

Rotary modules ERMB, electric

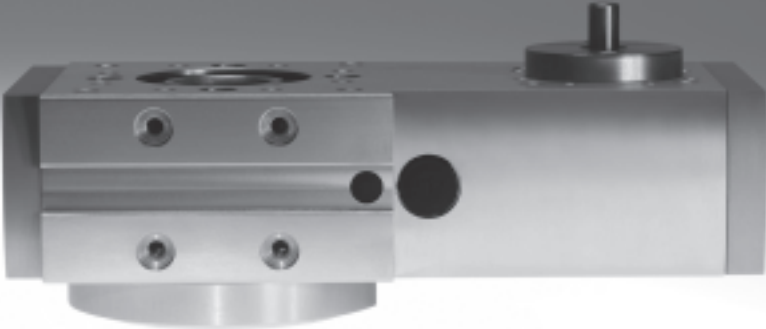

Rotary modules ERMB, electric

Key features

At a glance

The rotary module ERMB facilitates unlimited and flexible rotation angles. The output interface is the same as on the semi-rotary drive DRQD.

The motor's power is transmitted to the output pinion by means of a circulating toothed belt with a specific transmission ratio. The drive and

output pinions run on separate bearings. The toothed belt is pretensioned at the factory by means of an eccentric tensioning roller.

Advantages:

- Stable arrangement of the output shaft bearings
- Pretensioned toothed belt means zero backlash
- Compact design

The technology in detail

- 1 Interface with the motor, via axial kit
- 2 Mounting interface
- 3 Mounting for proximity sensor SIEN in the retaining ring
- 4 Output interface: Same as on the semi-rotary drive DRQD (with larger through-hole)

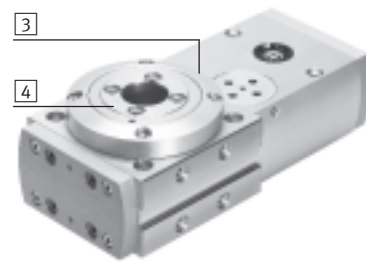
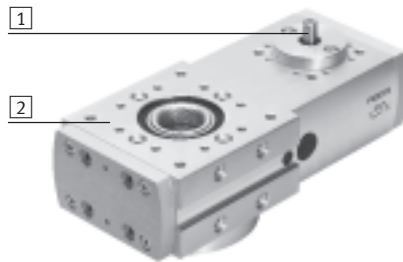

Sensing kit EAPS as an accessory

→ 14

The sensing kit facilitates monitoring of the angle of rotation using adjustable cams. It can also be used for reference checking.

Without housing

With housing

- 1 Trip cam support
- 2 Proximity sensor SIEN
- 3 Sensor bracket
- 4 Housing

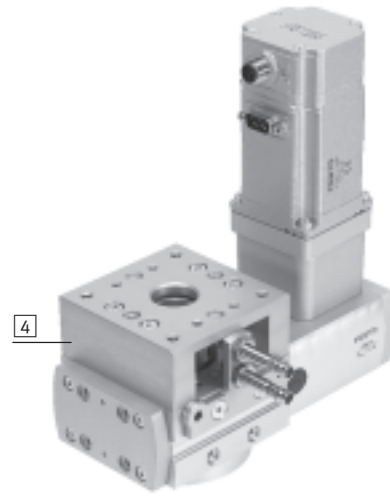
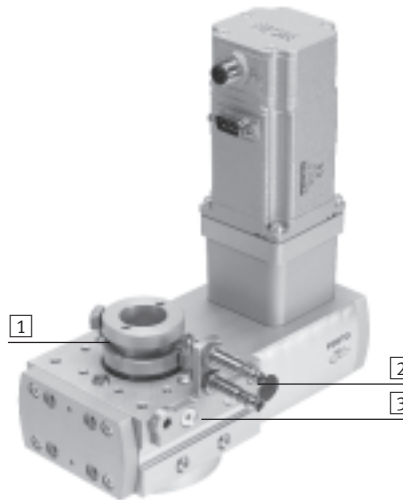

Mounting and installation options

Mounting option

The rotary module can be attached on six sides.

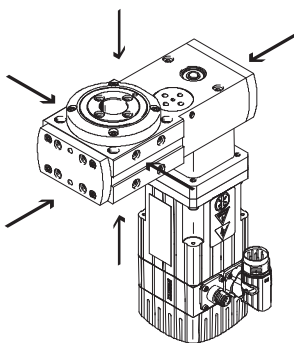

Installation option

As a front end

As a rotary table in a plate

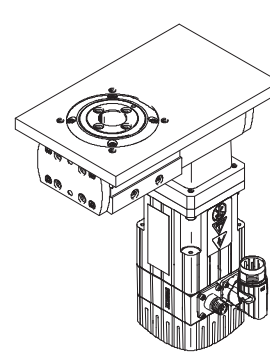
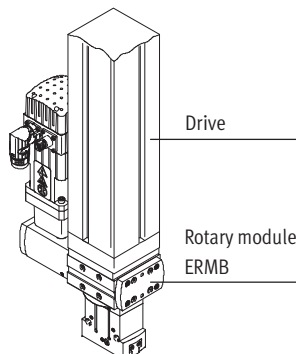

Rotary modules ERMB, electric

Key features

Total system comprising rotary module, motor and axial kit

Rotary module → 6

With axial kit

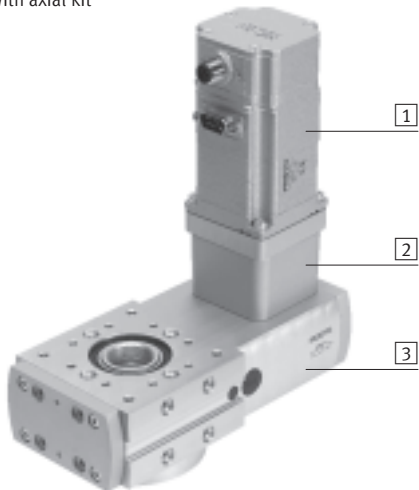

- 1 Motor
- 2 Axial kit
- 3 Rotary module

Motors → 16

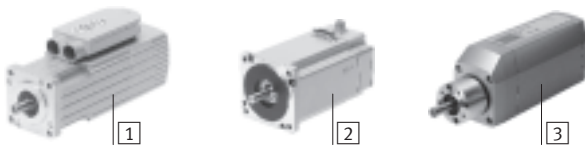

- 1 Servo motor EMMS-AS
- 2 Stepper motor EMMS-ST
- 3 Motor unit MTR-DCI

 **Note**
A range of specially adapted complete solutions is available for the rotary module ERMB.

Motor controllers

Technical data → Internet: motor controller

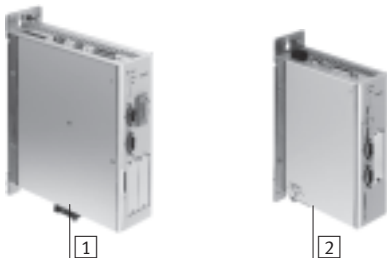

- 1 Servo motor controller
CMMP-AS, SEC-AC
- 2 Stepper motor controller
CMMS-ST

Axial kit → 16



- Kit comprising:
- Motor flange
 - Coupling housing
 - Coupling
 - Screws

Rotary modules ERMB, electric

Key features

System product for handling and assembly technology

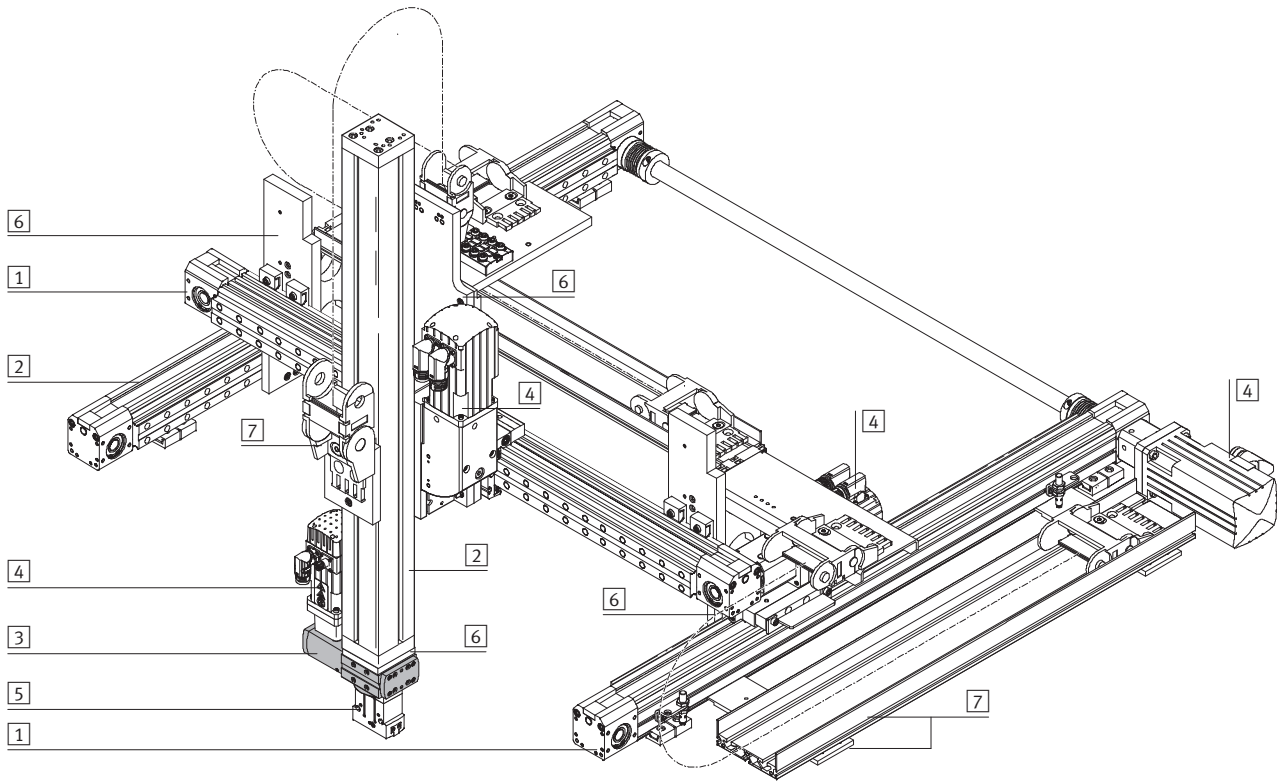

System components and accessories		
	Brief description	→ Page/Internet
1	Axes	Wide range of combinations possible within handling and assembly technology axes
2	Guide axes	For extending force and torque capacity in multi-axis applications guide axes
3	Rotary module	Wide range of combinations possible within handling and assembly technology rotary module
4	Motors	Servo or stepper motors, with or without gear unit motor
5	Gripper	Wide range of variations possible within handling and assembly technology gripper
6	Adapters	For drive/drive and drive/gripper connections adapter kit
7	Installation components	For a clean, safe layout of electrical cables and tubing installation component

Rotary modules ERMB, electric

Type code and peripherals overview

Type code

ERMB		25
Type		
ERMB	Rotary module	
Size		
20	Size 20	
25	Size 25	
32	Size 32	

Peripherals overview

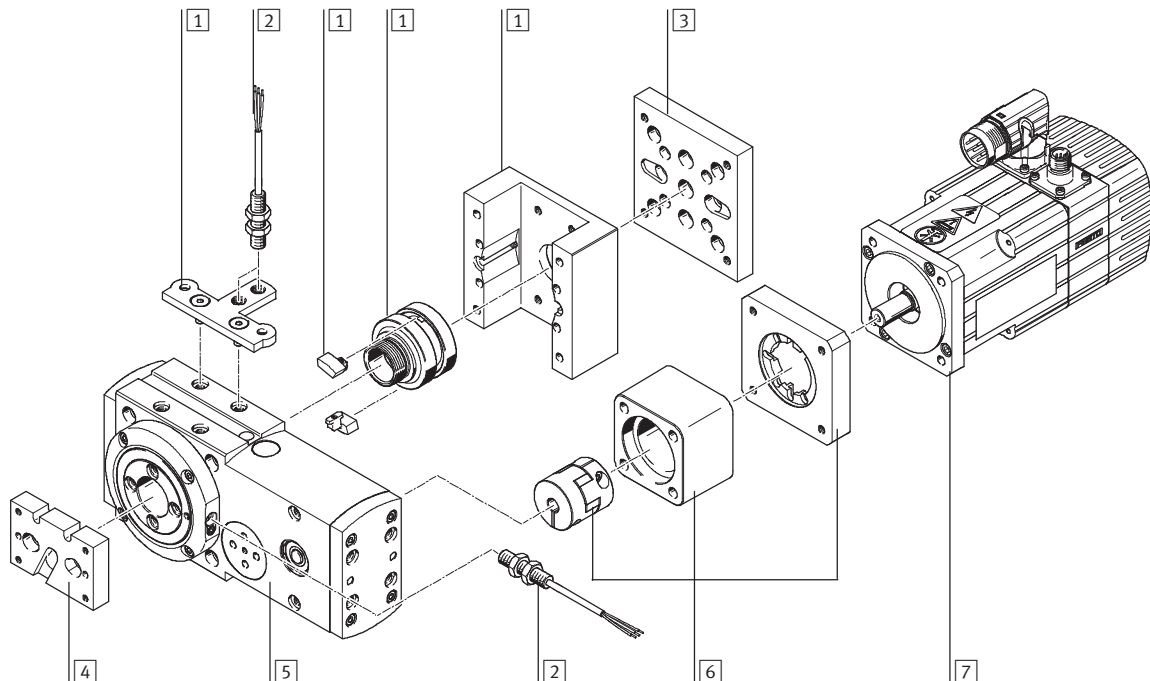

Accessories		
Type	Brief description	→ Page/Internet
1 Sensing kit EAPS	For indicating impermissible swivel angles, i.e. obstacles or areas that cannot be approached can be sensed using proximity sensors (comprising: housing, trip cam support, 2 cams and sensor bracket)	19
2 Proximity sensor SIEN	For use as a signal or safety check	19
3 Adapter kit	Interface between the rotary module and drive (the rotary module can be attached to a drive with or without a sensing kit)	adapter kit
4 Adapter kit	Interface between the rotary module and gripper	adapter kit
5 Rotary module ERMB	Facilitates unlimited and flexible rotation angles	6
6 Axial kit EAMM-A	For axial motor mounting (comprising: coupling, coupling housing and motor flange)	16
7 Motor EMMS, MTR-DCI	<ul style="list-style-type: none"> • Motors specially matched to the axis, with or without brake • The motor can be turned by 90° for mounting, depending on requirements. This means the connection side can be freely selected 	16

Rotary modules ERMB, electric

Technical data

 Size
20, 25, 32

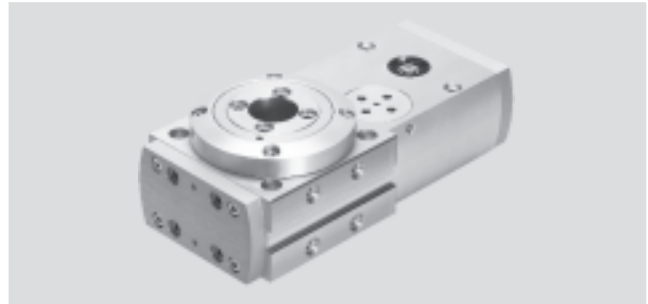

General technical data			
Size	20	25	32
Constructional design	Electromechanical rotary module with toothed belt		
Drive shaft \varnothing [mm]	6	8	12
Rotation angle	Infinite		
Repetition accuracy ¹⁾			
with servo motor EMMS-AS [°]	±0.03		
with stepper motor EMMS-ST ²⁾ [°]	±0.08		
with motor unit MTR-DCI [°]	±0.05		
Positioning times	→ 8		
Transmission ratio	4.5:1	4:1	3:1
Position sensing	Via proximity sensor		
Mounting position	Any		
Product weight [g]	850	1,460	3,250

- 1) As per FN 942 027
2) Depends on the encoder resolution

Mechanical data			
Size	20	25	32
Max. driving torque [Nm]	0.7	2.2	8.5
Max. output torque ¹⁾ [Nm]	3.15	8.8	25.5
No-load driving torque ²⁾ [Nm]	< 0.07	< 0.18	≤ 0.5
Max. input speed [rpm]	1,350	1,200	900
Max. output speed [rpm]	300	300	300
Max. mass moment of inertia ³⁾			
with servo motor EMMS-AS [kgcm ²]	50	200	1,000
with stepper motor EMMS-ST [kgcm ²]	30	100	500
with motor unit MTR-DCI-...-G7 [kgcm ²]	50	300	1,000
with motor unit MTR-DCI-...-G14 [kgcm ²]	200	1,200	3,700
Toothed belt pitch	2	3	5
Hollow shaft \varnothing [mm]	20	24	28

- 1) Output torque less friction depends on speed
2) At maximum speed
3) Depends on the size of the motor. Suitable motors → 16

Operating and environmental conditions			
Size	20	25	32
Ambient temperature [°C]	-10 ... +60		
Protection class	IP20		
Corrosion resistance class CRC ¹⁾	2		
Noise level L_{pEq} ²⁾ [dB (A)]	32	49	53

- 1) Corrosion resistance class 2 as per Festo standard 940 070
Components subject to moderate corrosion stress. Externally visible parts with primarily decorative surface requirements which are in direct contact with a normal industrial environment or media such as coolants or lubricating agents.
CRC 2 does not apply to ball bearings, retaining rings, screws < M5
2) In combination with servo motor EMMS-AS

Rotary modules ERMB, electric

Technical data

Materials

Sectional view

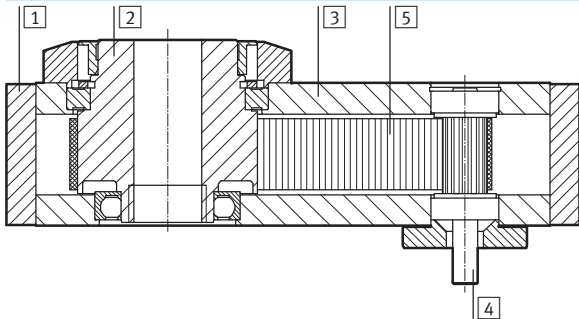

Rotary module		
1	End cap	Anodised aluminium
2	Output shaft	Wrought aluminium alloy, anodised
3	Housing	Wrought aluminium alloy, anodised
4	Drive shaft	High-alloy stainless steel
5	Toothed belt	Polychloroprene with glass fibres
-	Note on materials	Contains paint wetting impairment substances

Maximum radial and axial force Fx/Fy on the output shaft as a function of the distance y/z

If the rotary module is subjected to several forces at once, the following equation must be satisfied in addition to the maximum loads indicated below.

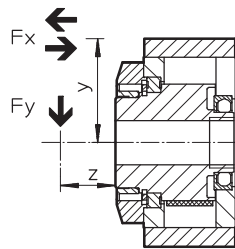

$$\frac{F_{y(z)}}{F_{y, \max.(z)}} + \frac{F_{x, \text{pushing}(v)}}{F_{x, \text{pushing}, \max.(v)}} + \frac{F_{x, \text{pulling}(v)}}{F_{x, \text{pulling}, \max.(v)}} \leq 1$$

Max. radial force Fy, static

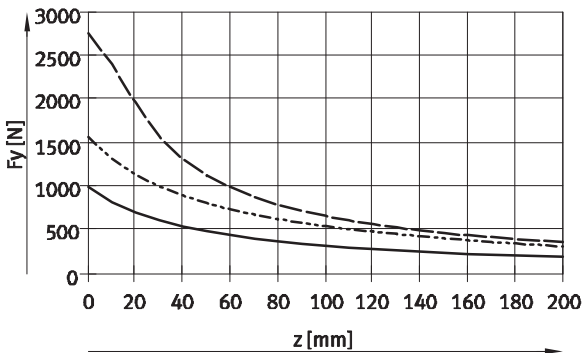

Max. radial force Fy, dynamic

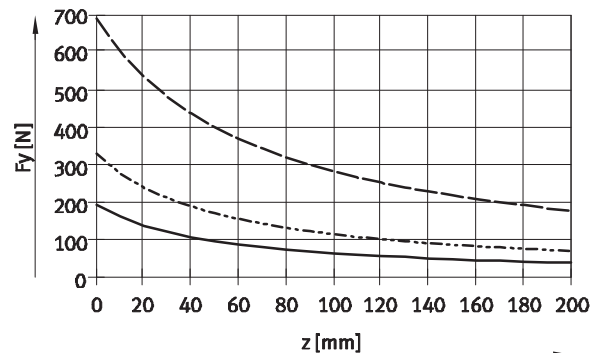

Max. axial force Fx, static, pushing and pulling

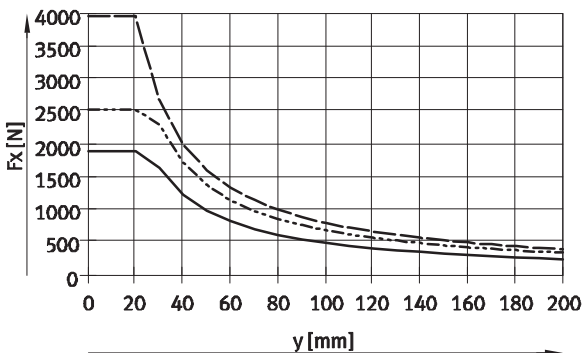

Max. axial force Fx, dynamic, pushing and pulling

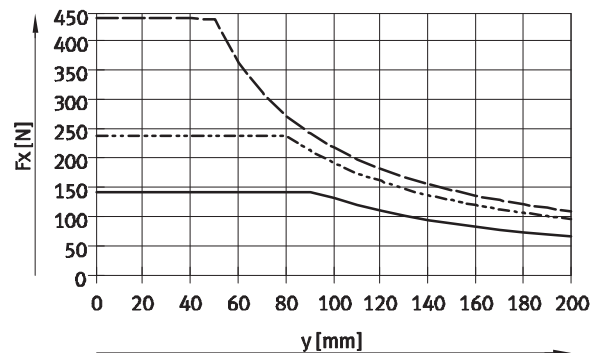

- ERMB-20
- - - ERMB-25
- · - ERMB-32

Rotary modules ERMB, electric



Technical data

Positioning time t as a function of the rotation angle α in combination with motor EMMS-.../motor unit MTR-DCI-...

Size 20

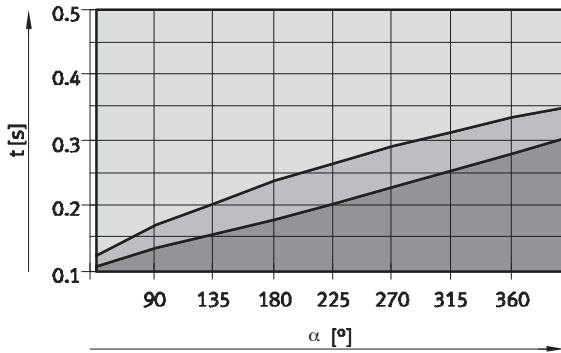

with servo motor EMMS-AS



-  Extended operating range
-  Typical operating range, depending on motor size and load inertia
-  Unrealisable range

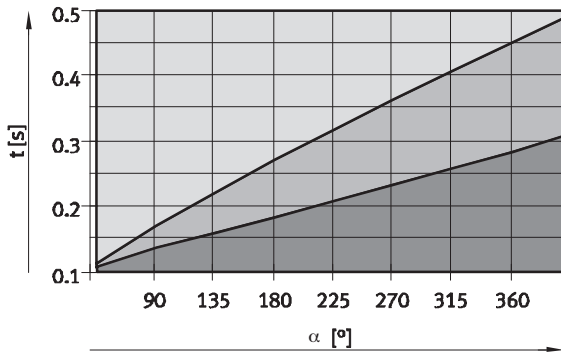

with stepper motor EMMS-ST

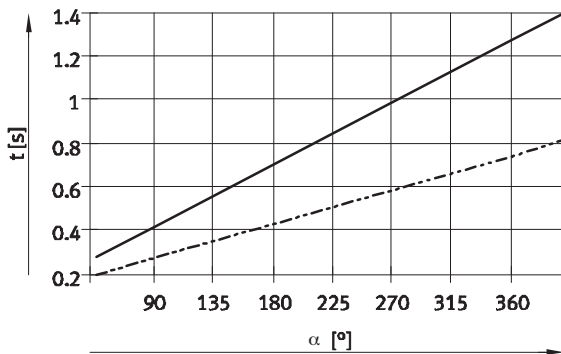

-  Extended operating range
-  Typical operating range, depending on motor size and load inertia
-  Unrealisable range

with motor unit MTR-DCI



-  Limit line for MTR-DCI-32-G14 at 0 ... 200 kgcm²
-  Limit line for MTR-DCI-32-G7 at 0 ... 50 kgcm²

 **Note**

The positioning time t ends with the controller signal MC (motion complete), i.e. on the drive side. Increased positioning times are to be expected at the output shaft depending on the motor type and eccentricity of the moving load.

For servo motor: 50 ... 100 ms
For stepper motor: 100 ... 200 ms

 **Note**

The "PositioningDrives" design tool compiles the optimum combination of rotary module and motor for the respective application with respect to mass moment of inertia, positioning time and positioning accuracy.
→ www.festo.com

Rotary modules ERMB, electric



Technical data

Positioning time t as a function of the rotation angle α in combination with motor EMMS-.../motor unit MTR-DCI-...

Size 25

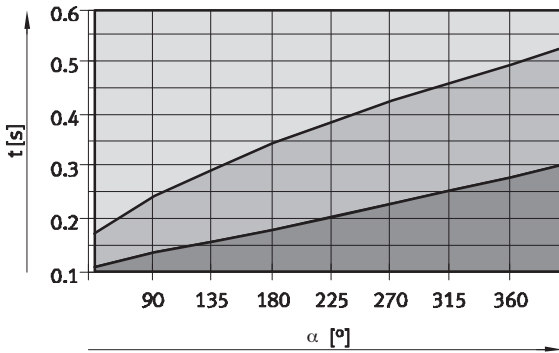

with servo motor EMMS-AS



-  Extended operating range
-  Typical operating range, depending on motor size and load inertia
-  Unrealisable range

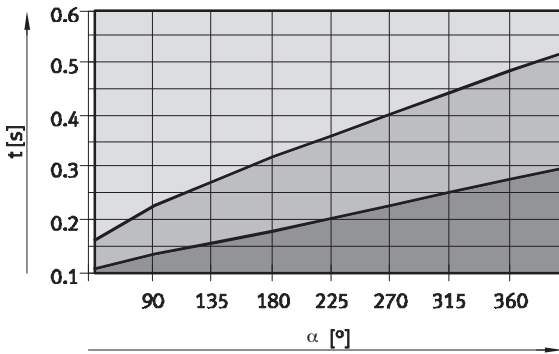

with stepper motor EMMS-ST

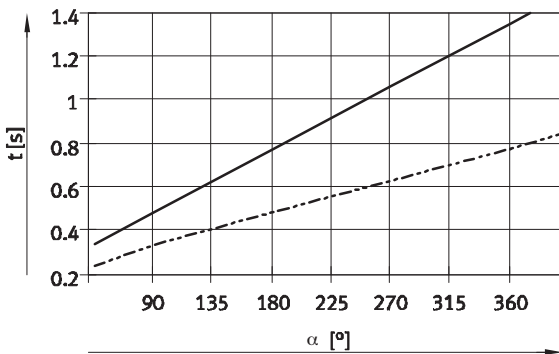

-  Extended operating range
-  Typical operating range, depending on motor size and load inertia
-  Unrealisable range

with motor unit MTR-DCI



-  Limit line for MTR-DCI-42-G14 at 0 ... 1,200 kgcm²
-  Limit line for MTR-DCI-42-G7 at 0 ... 300 kgcm²

 Note

The positioning time t ends with the controller signal MC (motion complete), i.e. on the drive side. Increased positioning times are to be expected at the output shaft depending on the motor type and eccentricity of the moving load.

For servo motor: 50 ... 100 ms
For stepper motor: 100 ... 200 ms

 Note

The “PositioningDrives” design tool compiles the optimum combination of rotary module and motor for the respective application with respect to mass moment of inertia and positioning time, positioning accuracy.

➔ www.festo.com

Rotary modules ERMB, electric



Technical data

Positioning time t as a function of the rotation angle α in combination with motor EMMS-.../motor unit MTR-DCI-...

Size 32

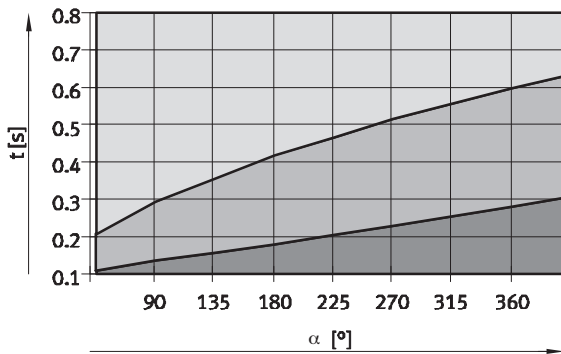

with servo motor EMMS-AS



-  Extended operating range
-  Typical operating range, depending on motor size and load inertia
-  Unrealisable range

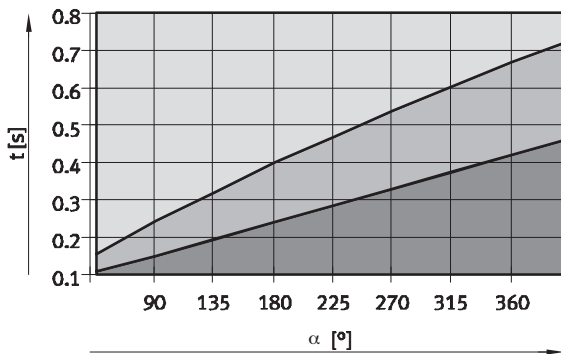

with stepper motor EMMS-ST

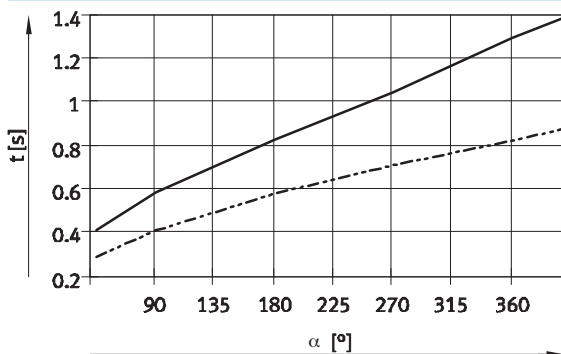

-  Extended operating range
-  Typical operating range, depending on motor size and load inertia
-  Unrealisable range

with motor unit MTR-DCI



-  Limit line for MTR-DCI-52-G14 at 0 ... 3,700 kgcm²
-  Limit line for MTR-DCI-52-G7 at 0 ... 1,000 kgcm²

 **Note**

The positioning time t ends with the controller signal MC (motion complete), i.e. on the drive side. Increased positioning times are to be expected at the output shaft depending on the motor type and eccentricity of the moving load.

For servo motor: 50 ... 100 ms
For stepper motor: 100 ... 200 ms

 **Note**

The “PositioningDrives” design tool compiles the optimum combination of rotary module and motor for the respective application with respect to mass moment of inertia and positioning time, positioning accuracy.
→ www.festo.com

Rotary modules ERMB, electric

Technical data

Information on service life characteristic values

Within the framework of product qualification, the specified statistic load changes/switching cycles were achieved with 3 samples.

Definition of load change/switching cycle:

A switching cycle corresponds to two load changes: position A to position B and back.

Size		20	25	32
Guide value load changes	[Mio.]	30	40	40
Guide value switching cycles	[Mio.]	15	20	20
Mass moment of inertia at output	[kgcm ²]	24	80	400
Medium angle acceleration at output	[°/sec ²]	28,000	20,000	12,000
Maximum angle speed at output	[°/sec]	1,800	1,800	1,800

The above specified statistic load change/switching cycles were achieved under the following defined operating conditions: horizontally hanging fitting, 180° swivel angle,

frequency 2 Hz, mass moment of inertia, acceleration (jerk-free) and max. angle speed as specified in the table, room temperature (23 ± 5) °C.

Under different operating conditions, a shorter or longer service life is possible. The conditions of use and safety regulations specified in the product documentation must also be taken into account.

Dimensions

[Download CAD data → www.festo.com](http://www.festo.com)

Size 20

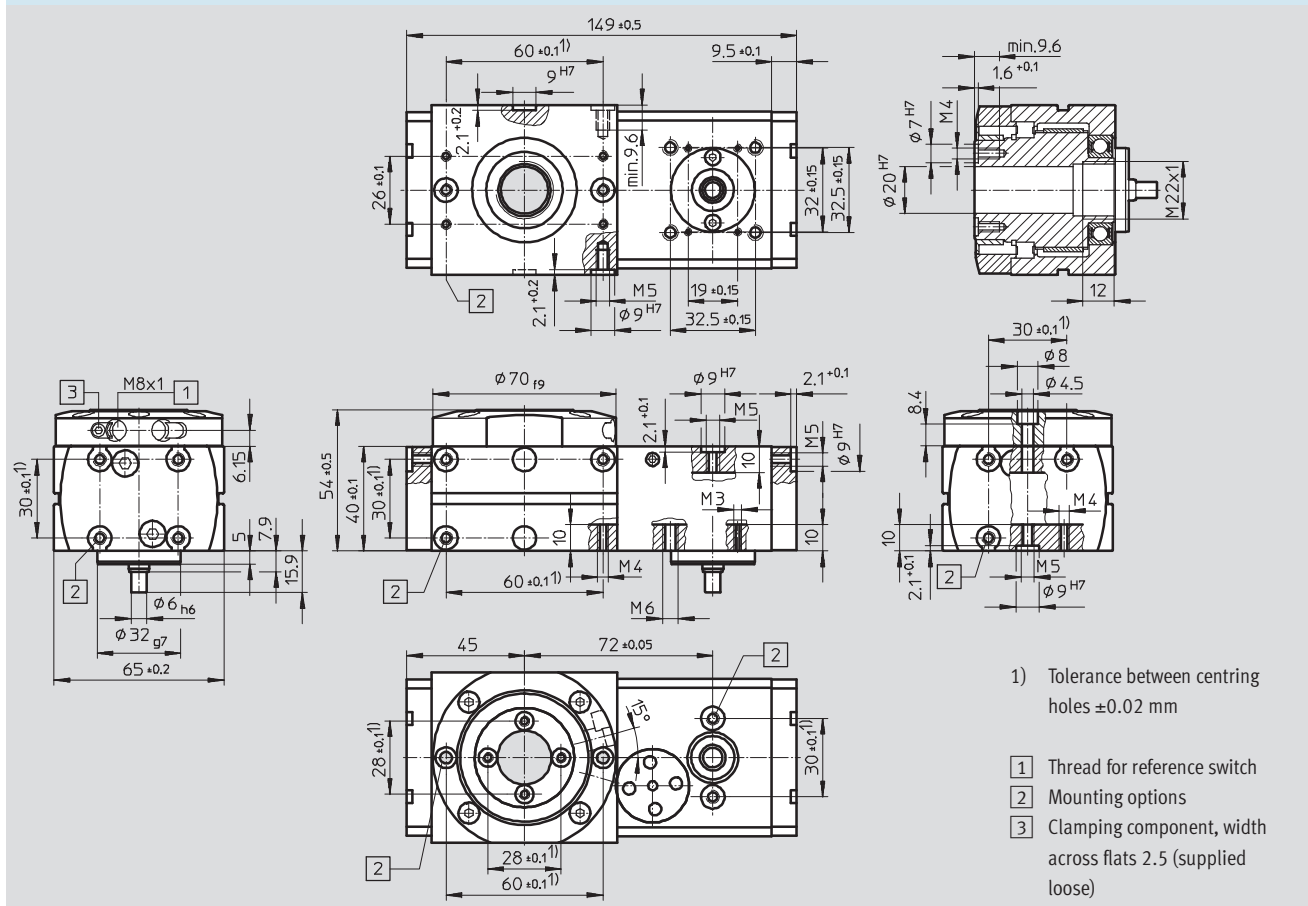

Rotary modules ERMB, electric

Technical data

Dimensions

Size 25/32

Download CAD data → www.festo.com

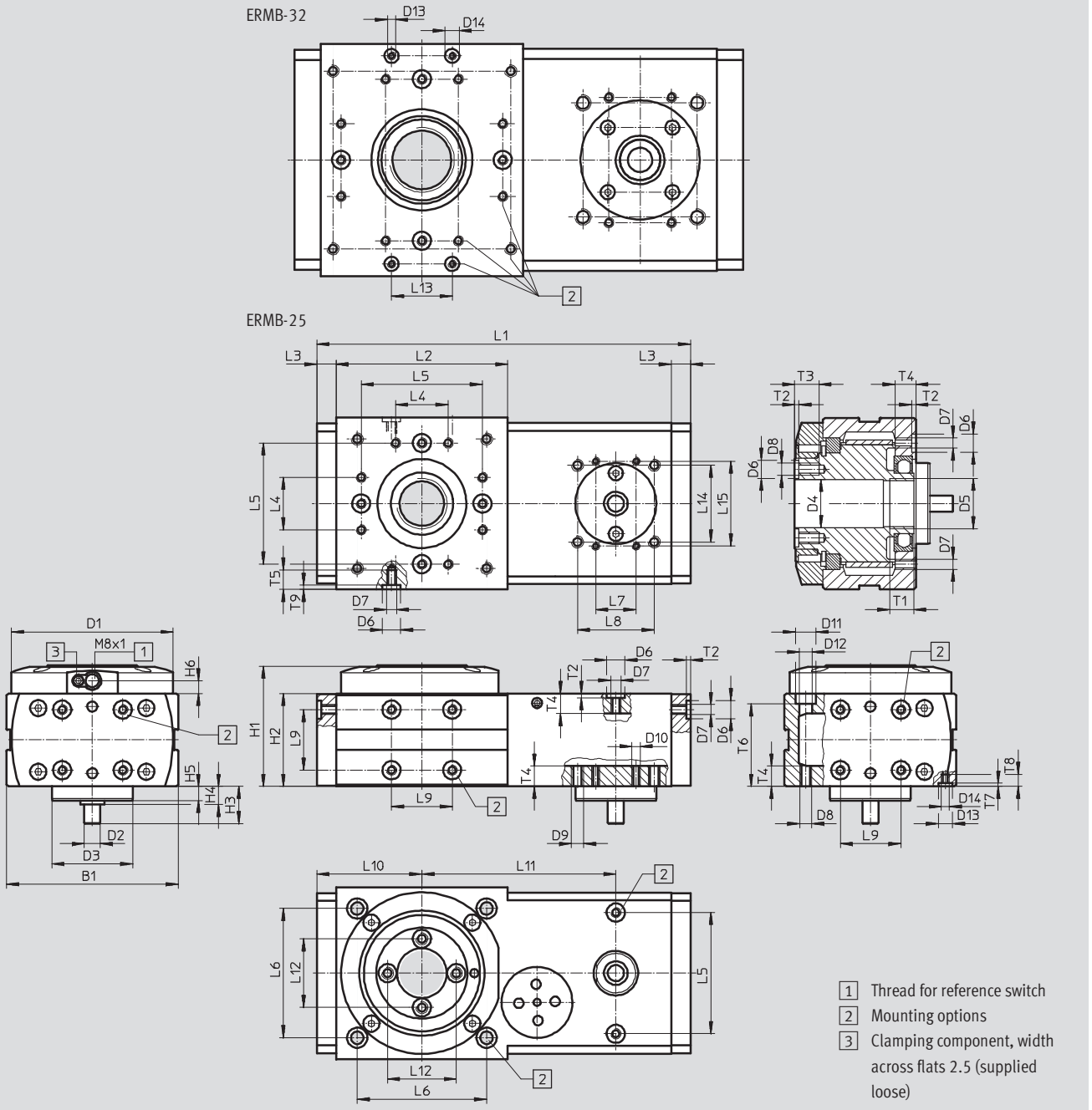

Rotary modules ERMB, electric

Technical data

FESTO

Size	B1 ±0.2	D1 ∅ f9	D2 ∅ h6	D3 ∅ g7	D4 ∅ H7	D5	D6 ∅ H7	D7	D8	D9	D10
25	85	80	8	40	24	M25x1	9	M5	M6	M6	M4
32	115	112	12	60	28	M32x1.5	9	M5	M6	M8	M5

Size	D11 ∅	D12 ∅	D13 ∅ H7	D14	H1 ±0.5	H2 ±0.1	H3	H4	H5	H6	L1 ±0.5
25	10	6.2	–	–	60	46	18.45	–	7	6.3	185
32	10	6.2	7	M4	76.05	60	23.5	6.5	6	9.4	222

Size	L2 ±0.2	L3 ±0.1	L4 ±0.1	L5 ¹⁾ ±0.1	L6	L7 ±0.15	L8 ±0.15	L9 ¹⁾ ±0.1	L10	L11 ±0.05	L12 ¹⁾ ±0.1	L13 ¹⁾ ±0.1
25	85	9.5	26	60	64±0.15	20	38	30	52	96	34	–
32	100	13	36	80	88±0.1	31	56.5	40	63	108	45	30

Size	L14 ±0.15	L15 ±0.15	L16 +0.2	T1	T2 +0.1	T3 min.	T4	T5 min.	T6	T7 +0.1	T8 min.	T9 +0.2
25	38	42	–	12	2.1	12	10	9.6	40.8±0.2	–	–	2.1
32	56.5	62	103	12	2.1	12	10	10	54.3	1.6	7.6	2.1

1) Tolerance between centring holes ±0.02 mm

Rotary modules ERMB, electric

Technical data

Dimensions

Download CAD data → www.festo.com

Sensing kit EAPS-R1-20-S for size 20

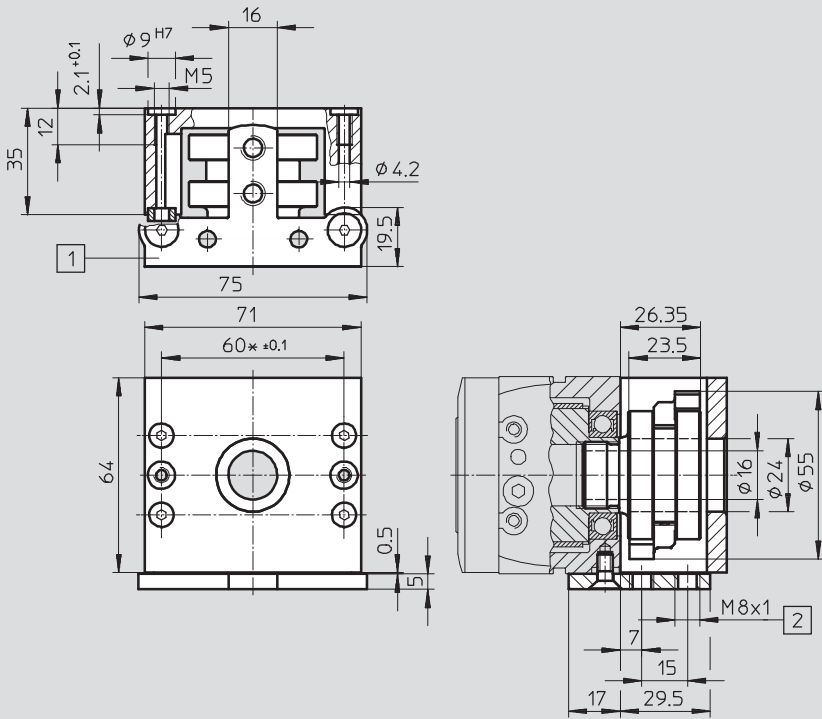

 Note
Ordering data → 19

- * Tolerance between centring holes ±0.02 mm
- 1 Bracket for proximity sensor SIEN-M8B
- 2 Thread for proximity sensor SIEN-M8B

Sensing kit EAPS-R1-25-S for size 25

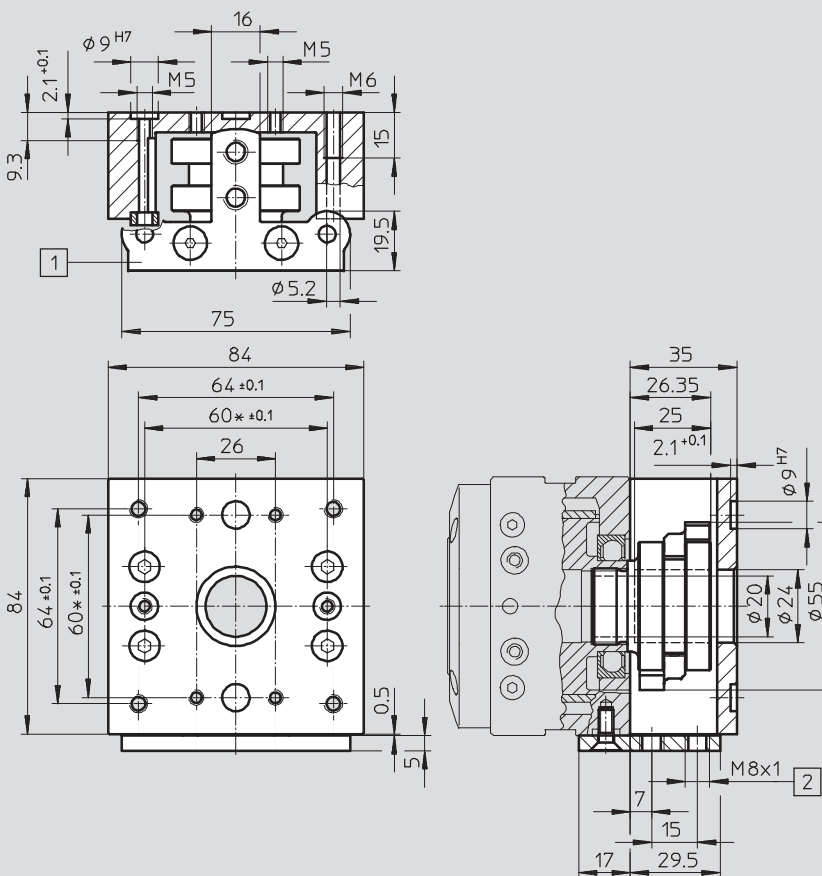

 Note
Ordering data → 19

- * Tolerance between centring holes ±0.02 mm
- 1 Bracket for proximity sensor SIEN-M8B
- 2 Thread for proximity sensor SIEN-M8B

Rotary modules ERMB, electric

Technical data

Dimensions

Download CAD data → www.festo.com

Sensing kit EAPS-R1-32-S for size 32

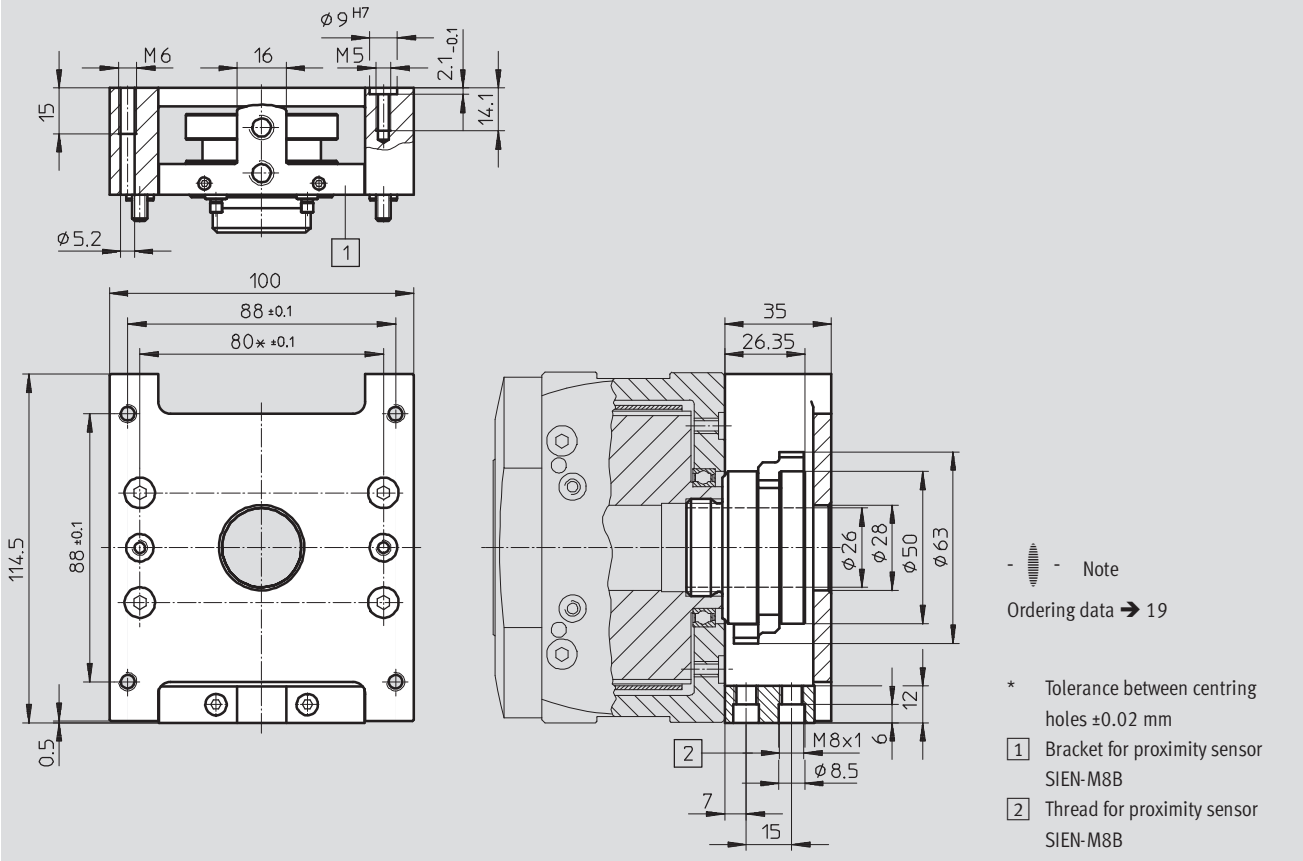

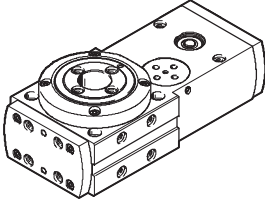

Rotary modules ERMB, electric

Technical data and accessories

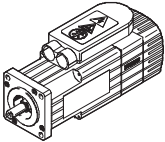
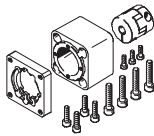

Ordering data				
	Size	Part No.	Type	
	20	552 706	ERMB-20	
	25	552 707	ERMB-25	
	32	552 708	ERMB-32	

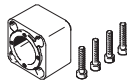

Accessories

Permissible axis/motor combinations with axial kit – Without gear unit				
Motor/motor unit	Axial kit	Axial kit comprising:		
		Motor flange	Coupling	Coupling housing
				
Type	Part No. Type	Part No. Type	Part No. Type	Part No. Type
ERMB-20				
with servo motor				
EMMS-AS-40-...	560 281 EAMM-A-D32-35A-40A	–	558 312 EAMC-30-32-6-6	560 280 EAMK-A-D32-35-40A
with stepper motor				
EMMS-ST-42-...	543 148 EAMM-A-D32-42A	552 164 EAMF-A-28B-42A	543 419 EAMC-16-20-5-6	552 155 EAMK-A-D32-28B
EMMS-ST-57-S-...	550 980 EAMM-A-D32-57A	530 081 EAMF-A-44A/B-57A	551 002 EAMC-30-32-6-6.35	551 006 EAMK-A-D32-44A
with motor unit				
MTR-DCI-32S-...	543 149 EAMM-A-D32-32B	–	543 420 EAMC-16-20-6-6	552 156 EAMK-A-D32-32B
ERMB-25				
with servo motor				
EMMS-AS-55-...	543 153 EAMM-A-D40-55A	529 942 EAMF-A-44A/B-55A	543 423 EAMC-30-32-8-9	552 157 EAMK-A-D40-44A
EMMS-AS-70-S-...	550 981 EAMM-A-D40-70A	529 943 EAMF-A-44A/B-70A	551 004 EAMC-30-32-8-11	552 157 EAMK-A-D40-44A
with stepper motor				
EMMS-ST-57-...	543 154 EAMM-A-D40-57A	530 081 EAMF-A-44A/B-57A	543 421 EAMC-30-32-6.35-8	552 157 EAMK-A-D40-44A
with motor unit				
MTR-DCI-42S-...-G7	543 155 EAMM-A-D40-42B	–	543 422 EAMC-30-32-8-8	552 158 EAMK-A-D40-42B
MTR-DCI-42S-...-G14	543 156 EAMM-A-D40-42C	–	543 422 EAMC-30-32-8-8	552 159 EAMK-A-D40-42C

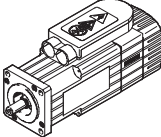
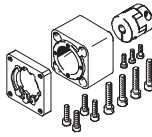
Rotary modules ERMB, electric

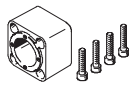
Accessories

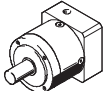
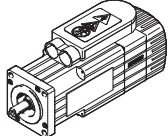
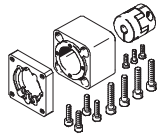
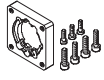
Permissible axis/motor combinations with axial kit – Without gear unit				
Motor/motor unit	Axial kit	Axial kit comprising:		
		Motor flange	Coupling	Coupling housing
				
Type	Part No. Type	Part No. Type	Part No. Type	Part No. Type
ERMB-32				
with servo motor				
EMMS-AS-70-M-...	543 161 EAMM-A-D60-70A	529 945 EAMF-A-64A/B-70A	543 424 EAMC-42-50-11-12	552 160 EAMK-A-D60-64B
EMMS-AS-100-S-...	550 983 EAMM-A-D60-100A	529 947 EAMF-A-64A/C-100A	551 005 EAMC-42-50-12-19	551 007 EAMK-A-D60-64C
with stepper motor				
EMMS-ST-87-M-...	543 162	533 140	543 424	552 160
EMMS-ST-87-L-...	EAMM-A-D60-87A	MTR-FL64-ST87	EAMC-42-50-11-12	EAMK-A-D60-64B
with motor unit				
MTR-DCI-52S-...-G7	543 163 EAMM-A-D60-52B	–	533 709 EAMC-42-50-12-12	552 161 EAMK-A-D60-52B
MTR-DCI-52S-...-G14	543 164 EAMM-A-D60-52C	–	533 709 EAMC-42-50-12-12	552 162 EAMK-A-D60-52C

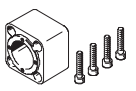
Permissible axis/motor combinations with axial kit – With gear unit					
Gear unit	Motor	Axial kit	Axial kit comprising:		
			Motor flange	Coupling	Coupling housing
					
Type	Type	Part No. Type	Part No. Type	Part No. Type	Part No. Type
ERMB-25					
with servo motor					
EMGA-40-P-G3-SAS-40	EMMS-AS-40-...	560 282 EAMM-A-D40-40G	550 986 EAMF-A-44A/B-40G	558 029 EAMC-30-32-8-10	552 157 EAMK-A-D40-44A
ERMB-32					
with servo motor					
EMGA-60-P-G...-SAS-55	EMMS-AS-55-...	560 283 EAMM-A-D60-60G	550 987 EAMF-A-64A/B-60G	543 424 EAMC-42-50-11-12	552 160 EAMK-A-D60-64B
EMGA-60-P-G3-SAS-70	EMMS-AS-70-...	560 283 EAMM-A-D60-60G	550 987 EAMF-A-64A/B-60G	543 424 EAMC-42-50-11-12	552 160 EAMK-A-D60-64B

 Note

Note the maximum permissible drive torque of the ERMB. The motor current may need to be limited.

Rotary modules ERMB, electric

Accessories

Axial kit EAMM-A-...

Material:

Coupling housing, coupling hubs,

motor flange: Aluminium

Screws: Galvanised steel

Clamping component:

Steel, corrosion resistant

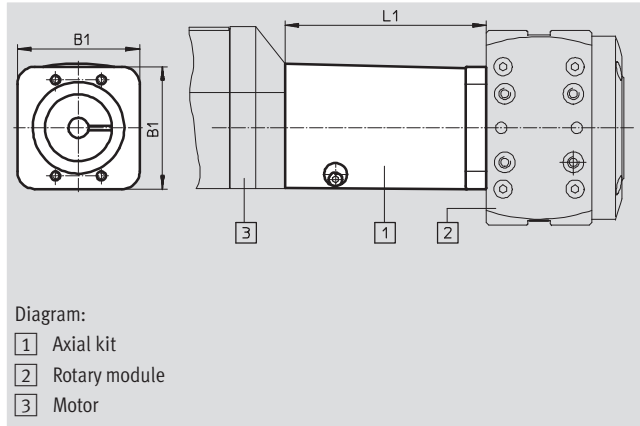

General technical data									
EAMM-A-...		D32-				D40-			
		32B	35-40A	42A	57A	42B	42C	55A	57A
Transferable torque	[Nm]	1.1	4.0	0.8	4.0	8.0			6.0
Mass moment of inertia	[kgmm ²]	0.3	5.87	0.3	5.87	5.87			
Mounting position		Any				Any			

EAMM-A-...		D40-		D60-					
		70A	40G	52B	52C	70A	87A	100A	60G
Transferable torque	[Nm]	8.0		14.0		12.0		14.0	12.0
Mass moment of inertia	[kgmm ²]	5.87		35.5					
Mounting position		Any							

Operating and environmental conditions		
Ambient temperature	[°C]	0 ... 50
Storage temperature	[°C]	-25 ... +60
Protection class ¹⁾		IP40
Relative air humidity	[%]	0 ... 95

1) Only with combined attachment of motor and axis





Dimensions and ordering data					
Type	B1	L1	Weight [g]	Part No.	Type
EAMM-A-D32-32B	45	43	150	543 149	EAMM-A-D32-32B
EAMM-A-D32-35A-40A	40	46	220	560 281	EAMM-A-D32-35A-40A
EAMM-A-D32-42A	45	48	140	543 148	EAMM-A-D32-42A
EAMM-A-D32-57A	45	50.5	270	550 980	EAMM-A-D32-57A
EAMM-A-D40-42B	53.5	88	340	543 155	EAMM-A-D40-42B
EAMM-A-D40-42C	53.5	101	370	543 156	EAMM-A-D40-42C
EAMM-A-D40-40G	53.5	55.5	350	560 282	EAMM-A-D40-40G
EAMM-A-D40-55A	53.5	49.2	350	543 153	EAMM-A-D40-55A
EAMM-A-D40-57A	53.5	50.5	350	543 154	EAMM-A-D40-57A
EAMM-A-D40-70A	53.5	52	410	550 981	EAMM-A-D40-70A
EAMM-A-D60-52B	74	112	930	543 163	EAMM-A-D60-52B
EAMM-A-D60-52C	74	126	1,020	543 164	EAMM-A-D60-52C
EAMM-A-D60-60G	74	71.4	830	560 283	EAMM-A-D60-60G
EAMM-A-D60-70A	74	63.2	750	543 161	EAMM-A-D60-70A
EAMM-A-D60-87A	74	64.7	890	543 162	EAMM-A-D60-87A
EAMM-A-D60-100A	74	78.2	1,170	550 983	EAMM-A-D60-100A

Rotary modules ERMB, electric

Accessories

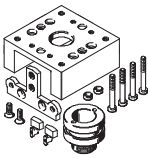
Ordering data – Centring sleeves						
	For size	Brief description	Number	Part No.	Type	PU ¹⁾
	20	For centring loads and attachments (centring sleeves are included in the scope of delivery of the rotary module)	2	186 717	ZBH-7	10
	25, 32		2	150 927	ZBH-9	
			4			

1) Packaging unit quantity

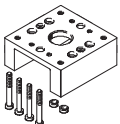
Ordering data						
	For size	Brief description	Weight [g]	Part No.	Type	PU ¹⁾
Sensing kit EAPS-...-S						
	20	Kit with housing (trip cam support, 2 cams, sensor bracket)	258	558 392	EAPS-R1-20-S	1
	25		406	558 393	EAPS-R1-25-S	
	32		560	558 394	EAPS-R1-32-S	
Sensing kit without housing EAPS-...-S-WH						
	20	Kit without housing (trip cam support, 2 cams, sensor bracket)	86	558 395	EAPS-R1-20-S-WH	1
	25		90	558 396	EAPS-R1-25-S-WH	
	32		136	558 397	EAPS-R1-32-S-WH	
Cam EAPS-...-CK						
	20, 25, 32	For sensing positions (the scope of delivery includes two cams)	5 each	558 398	EAPS-R1-CK	2
Sensor bracket EAPS-...-SH						
	20, 25	For attaching proximity sensors to the rotary module	24	558 399	EAPS-R1-20-SH	1
	32		30	558 400	EAPS-R1-32-SH	
Housing EAPS-...-H						
	20	For protecting the sensing kit and as mounting interface with a drive	172	560 673	EAPS-R1-20-H	1
	25		316	560 674	EAPS-R1-25-H	
	32		424	560 675	EAPS-R1-32-H	

Ordering data – Proximity sensors, inductive				Technical data → Internet: sien	
	Contact	Connection	Part No.	Type	
	N/O contact	Cable, 2.5 m	150 386	SIEN-M8B-PS-K-L	
		Plug	150 387	SIEN-M8B-PS-S-L	
	N/C contact	Cable, 2.5 m	150 390	SIEN-M8B-PO-K-L	
		Plug	150 391	SIEN-M8B-PO-S-L	

Ordering data – Connecting cables				Technical data → Internet: nebu	
	Electrical connection, left	Electrical connection, right	Cable length [m]	Part No.	Type
	Straight socket, M8x1, 3-pin	Cable, open end, 3-wire	2.5	541 333	NEBU-M8G3-K-2.5-LE3
			5	541 334	NEBU-M8G3-K-5-LE3