

V60 ... V63, 3/2, 2 x 3/2, 5/2 oder 5/3 Elektropneumatisch & pneumatisch betätigte Kolbenschieberventile



- > Anschluss: 1/8" ... 1/2" (ISO G/NPT)
- > Hoher Durchfluss bei geringer Baugröße
- > Vielfach bewährtes Dichtsystem, wartungsfrei
- > Handhilfsbetätigung nach Wahl
- > Geringe elektrische Leistungsaufnahme
- > Verkettungssystem für einfache Montage
- > Verschiedene Druckbereiche möglich



Technische Merkmale

Betriebsmedium:

Gefilterte, ölfreie oder geölte Druckluft

Betätigung:

Elektropneumatisch oder pneumatisch gesteuert

Betriebsdruck:

-0,9 ... 10 bar (-13 ... 145 psi)

Details folgende Seite

Durchfluss:

500 ... 4500 l/min

Durchflussrichtung:

Bei interner Steuerluftversorgung: festgelegt.

Bei externer Steuerluftversorgung:

beliebig

Anschluss:

G1/8, G1/4, G3/8 or G1/2

Ventile mit NPT-Anschlüssen siehe Typenschlüssel

Einbaulage:

Beliebig, Impulsventile vorzugsweise waagrecht

Umgebungs-/Mediums-temperatur:

-10 ... +50°C (+14 ... +122°F)

Um das Einfrieren der beweglichen

Teile zu vermeiden, muss

die Druckluft unter +2°C (+35°F) frei von Feuchtigkeit sein.

Material:

Gehäuse:

Aluminium-Strangpressprofil

Grundplatten: Aluminium

Statische- und dynamische

Dichtungen: NBR und FPM

Kunststoffteile: PA, PBT mit GF

Kenngrößen für Elektromagnete

Spannungstoleranz	± 10%
Relative Einschaltdauer	100% Dauerbetrieb
Nennweite	0,8 mm
Elektrischer Anschluss (entsprechend ausgewählter Spule)	EN 175301-803 - Form B, 22 mm Industriestandard, 22 mm
Magnetspule	4 x 90° drehbar
Handhilfsbetätigung	Ohne # = 1 Arretierbar # = 2 Nicht arretierbar # = 3
Schutzart	IP 65 (mit Steckverbinder)

3/2-Wegeventile, elektropneumatisch betätigt

Symbol	Anschluss	Funktion	Betätigung / Rückstellung	Steuerluft	Durchfluss (l/min)	Betriebsdruck (bar)	Steuerdruck (bar)	Gewicht (kg)	Zeichnung Nr.	Typ *1)
	G1/8	NC	El. magnet/Feder	Intern	750	2 ... 10	-	0,22	1	V60A417A-A#*
	G1/4	NC	El. magnet/Feder	Intern	1300	2 ... 10	-	0,29	1	V61B417A-A#*
	G3/8	NC	El. magnet/Feder	Intern	2600	2 ... 10	-	0,52	1	V62C417A-A#*
	G1/2	NC	El. magnet/Feder	Intern	4500	2 ... 10	-	0,78	2	V63D417A-A#*
	G1/8	NC	El. magnet/Luftfeder	Intern	750	2 ... 10	-	0,22	3	V60A413A-A#*
	G1/4	NC	El. magnet/Luftfeder	Intern	1300	2 ... 10	-	0,29	3	V61B413A-A#*
	G3/8	NC	El. magnet/Luftfeder	Intern	2600	2 ... 10	-	0,52	3	V62C413A-A#*
	G1/2	NC	El. magnet/Luftfeder	Intern	4500	3 ... 10	-	0,78	4	V63D413A-A#*
	G1/8	NC	El. magnet/Luftfeder	Extern	750	-0,9 ... 10	3 ... 10	0,22	3	V60A423A-A#*
	G1/4	NC	El. magnet/Luftfeder	Extern	1300	-0,9 ... 10	3 ... 10	0,29	3	V61B423A-A#*
	G3/8	NC	El. magnet/Luftfeder	Extern	2600	-0,9 ... 10	3 ... 10	0,52	3	V62C423A-A#*
	G1/2	NC	El. magnet/Luftfeder	Extern	4500	-0,9 ... 10	3 ... 10	0,78	4	V63D423A-A#*
	G1/8	NO	El. magnet/Luftfeder	Intern	750	2 ... 10	-	0,22	5	V60A313A-A#*
	G1/4	NO	El. magnet/Luftfeder	Intern	1300	2 ... 10	-	0,29	5	V61B313A-A#*
	G3/8	NO	El. magnet/Luftfeder	Intern	2600	2 ... 10	-	0,52	5	V62C313A-A#*
	G1/2	NO	El. magnet/Luftfeder	Intern	4500	3 ... 10	-	0,78	6	V63D313A-A#*
	G1/8	-	El. magnet/El. magnet	Intern	750	1,5 ... 10	-	0,30	7	V60A411A-A#*
	G1/4	-	El. magnet/El. magnet	Intern	1300	1,5 ... 10	-	0,38	7	V61B411A-A#*
	G3/8	-	El. magnet/El. magnet	Intern	2600	1,5 ... 10	-	0,61	7	V62C411A-A#*
	G1/2	-	El. magnet/El. magnet	Intern	4500	2 ... 10	-	0,87	8	V63D411A-A#*

2 x 3/2-Wegeventile, elektropneumatisch betätigt

Symbol	Anschluss	Funktion	Betätigung/ Rückstellung	Steuerluft	Durchfluss (l/min)	Betriebsdruck (bar)	Gewicht (kg)	Zeichnung Nr.	Typ *1)
	G1/8	NC/NC	El. magnet/El. magnet	Intern	500	2 ... 10	0,34	13	V60AA11A-A#*
	G1/4	NC/NC	El. magnet/El. magnet	Intern	950	2 ... 10	0,43	13	V61BA11A-A#*
	G3/8	NC/NC	El. magnet/El. magnet	Intern	1900	2 ... 10	0,73	13	V62CA11A-A#*
	G1/8	NO/NO	El. magnet/El. magnet	Intern	500	2 ... 10	0,34	13	V60AB11A-A#*
	G1/4	NO/NO	El. magnet/El. magnet	Intern	950	2 ... 10	0,43	13	V61BB11A-A#*
	G3/8	NO/NO	El. magnet/El. magnet	Intern	1900	2 ... 10	0,73	13	V62CB11A-A#*
	G1/8	NO/NC	El. magnet/El. magnet	Intern	500	2 ... 10	0,34	13	V60AC11A-A#*
	G1/4	NO/NC	El. magnet/El. magnet	Intern	950	2 ... 10	0,43	13	V61BC11A-A#*
	G3/8	NO/NC	El. magnet/El. magnet	Intern	1900	2 ... 10	0,73	13	V62CC11A-A#*

Bitte Code für Handhilfsbetätigung einfügen: 1 = ohne; 2 = arretierbar; 3 = nicht arretierbar

*1) Spannungscode aus der Tabelle unten einfügen oder 000 für Ausführung ohne Magnet

NC = Sperr-Nullstellung; NO = Durchfluss-Nullstellung

NC/NC = Beide Ventile in Ruhestellung geschlossen (Anschluss P)

NO/NO = Beide Ventile in Ruhestellung geöffnet (Anschluss P)

NO/NC = Ventil in Ruhestellung geöffnet, 1 Ventil in Ruhestellung geschlossen (Anschluss P)

Spannungskennziffern und Ersatzspulen

22 mm -Spule ohne Steckverbinder nach Industriestandard				
Spannung	Anzugs-/Halteleistung	Typ	Code	
12 V DC	2 W	QM/48/12J/21	12J	
24 V DC	2 W	QM/48/13J/21	13J	
24 V 50/60 Hz	4/2,5 VA	QM/48/14J/21	14J	
110/120 V 50/60 Hz	4/2,5 VA	QM/48/18J/21	18J	
220/240 V 50/60 Hz	6/5,0 VA	QM/48/19J/21	19J	

22 mm coil for connector interface acc. EN 175 301-803, form B				
Spannung	Anzugs-/Halteleistung	Typ	Code	
12 V DC	2 W	V10626-A12L	12L	
24 V DC	2 W	V10626-A13L	13L	
24 V 50/60 Hz	4/2,5 VA	V10626-A14L	14L	
110/120 V 50/60 Hz	4/2,5 VA	V10626-A18L	18L	
220/240 V 50/60 Hz	6/5,0 VA	V10626-A19L	19L	

Other voltage on request.

Steckverbinder, bitte separat bestellen

Industriestandard 22 mm 2-polig + PE	22 mm, EN 175301-803 (DIN 43650 B) Form B 2-polig + PE
	
0657868 12...250 V AC/DC	0680003 12...250 V AC/DC
0680000 15...30 V DC; LED, Schutzbeschaltung	0664811 15...30 V DC; LED, Schutzbeschaltung
0680001 150...250 V AC; Glimmlampe	0664812 150...250 V AC; Glimmlampe

Hinweis: leuchtende Dichtungen nicht verwendbar

5/2-Wegeventile, elektropneumatisch betätigt

Symbol	Anschluss	Betätigung / Rückstellung	Steuerluft	Durchfluss (l/min)	Betriebsdruck (bar)	Steuerdruck (bar)	Gewicht (kg)	Zeichnung Nr.	Typ*1)
	G1/8	El. magnet/Feder	Intern	750	3 ... 10	-	0,22	9	V60A517A-A#*
	G1/4	El. magnet/Feder	Intern	1300	3 ... 10	-	0,29	9	V61B517A-A#*
	G3/8	El. magnet/Feder	Intern	2600	3 ... 10	-	0,52	9	V62C517A-A#*
	G1/2	El. magnet/Feder	Intern	4500	3 ... 10	-	0,96	10	V63D517A-A#*
	G1/8	El. magnet/Luftfeder	Intern	750	2 ... 10	-	0,24	11	V60A513A-A#*
	G1/4	El. magnet/Luftfeder	Intern	1300	2 ... 10	-	0,33	11	V61B513A-A#*
	G3/8	El. magnet/Luftfeder	Intern	2600	2 ... 10	-	0,62	11	V62C513A-A#*
	G1/2	El. magnet/Luftfeder	Intern	4500	3 ... 10	-	0,96	12	V63D513A-A#*
	G1/8	El. magnet/Luftfeder	Extern	750	-0,9 ... 10	3 ... 10	0,24	11	V60A523A-A#*
	G1/4	El. magnet/Luftfeder	Extern	1300	-0,9 ... 10	3 ... 10	0,33	11	V61B523A-A#*
	G3/8	El. magnet/Luftfeder	Extern	2600	-0,9 ... 10	3 ... 10	0,62	11	V62C523A-A#*
	G1/2	El. magnet/Luftfeder	Extern	4500	-0,9 ... 10	3 ... 10	0,96	12	V63D523A-A#*
	G1/8	El. magnet/El. magnet	Intern	750	1,5 ... 10	-	0,33	13	V60A511A-A#*
	G1/4	El. magnet/El. magnet	Intern	1300	1,5 ... 10	-	0,42	13	V61B511A-A#*
	G3/8	El. magnet/El. magnet	Intern	2600	1,5 ... 10	-	0,72	13	V62C511A-A#*
	G1/2	El. magnet/El. magnet	Intern	4500	2 ... 10	-	0,98	14	V63D511A-A#*

5/3-Wegeventile, elektropneumatisch betätigt

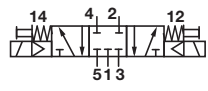
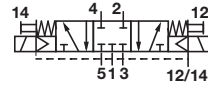
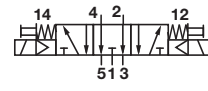
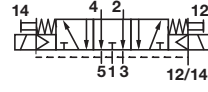
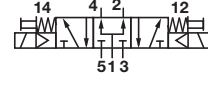
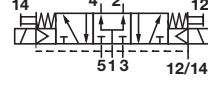
Symbol	Anschluss	Funktion	Betätigung / Rückstellung	Steuerluft	Durchfluss (l/min)	Betriebsdruck (bar)	Steuerdruck (bar)	Gewicht (kg)	Zeichnung Nr.	Typ*1)
	G1/8	APB	El. magnet/El. magnet	Intern	500	3 ... 10	-	0,35	15	V60A611A-A#*
	G1/4	APB	El. magnet/El. magnet	Intern	950	3 ... 10	-	0,47	15	V61B611A-A#*
	G3/8	APB	El. magnet/El. magnet	Intern	1900	3 ... 10	-	0,81	15	V62C611A-A#*
	G1/8	APB	El. magnet/El. magnet	Extern	500	-0,9 ... 10	3 ... 10	0,35	15	V60A622A-A#*
	G1/4	APB	El. magnet/El. magnet	Extern	950	-0,9 ... 10	3 ... 10	0,47	15	V61B622A-A#*
	G3/8	APB	El. magnet/El. magnet	Extern	1900	-0,9 ... 10	3 ... 10	0,81	15	V62C622A-A#*
	G1/8	COE	El. magnet/El. magnet	Intern	500	3 ... 10	-	0,35	15	V60A711A-A#*
	G1/4	COE	El. magnet/El. magnet	Intern	950	3 ... 10	-	0,47	15	V61B711A-A#*
	G3/8	COE	El. magnet/El. magnet	Intern	1900	3 ... 10	-	0,81	15	V62C711A-A#*
	G1/8	COE	El. magnet/El. magnet	Extern	500	-0,9 ... 10	3 ... 10	0,35	15	V60A722A-A#*
	G1/4	COE	El. magnet/El. magnet	Extern	950	-0,9 ... 10	3 ... 10	0,47	15	V61B722A-A#*
	G3/8	COE	El. magnet/El. magnet	Extern	1900	-0,9 ... 10	3 ... 10	0,81	15	V62C722A-A#*
	G1/8	COP	El. magnet/El. magnet	Intern	500	3 ... 10	-	0,35	15	V60A811A-A#*
	G1/4	COP	El. magnet/El. magnet	Intern	950	3 ... 10	-	0,47	15	V61B811A-A#*
	G3/8	COP	El. magnet/El. magnet	Intern	1900	3 ... 10	-	0,81	15	V62C811A-A#*
	G1/8	COP	El. magnet/El. magnet	Extern	500	-0,9 ... 10	3 ... 10	0,35	15	V60A822A-A#*
	G1/4	COP	El. magnet/El. magnet	Extern	950	-0,9 ... 10	3 ... 10	0,47	15	V61B822A-A#*
	G3/8	COP	El. magnet/El. magnet	Extern	1900	-0,9 ... 10	3 ... 10	0,81	15	V62C822A-A#*

Bitte Code für Handhilfsbetätigung einfügen: 1 = ohne; 2 = arretierbar; 3 = nicht arretierbar

*1) Spannungscode aus der Tabelle Seite 2 einfügen oder 000 für Ausführung ohne Magnet

APB = All ports blocked – in Mittelstellung alle Anschlüsse gesperrt

COE = Centre open exhaust – in Mittelstellung Anschluss 2+4 entlüftet

COP = Centre open pressure – in Mittelstellung Anschluss 2+4 belüftet

3/2-Wegeventile, pneumatisch betätigt

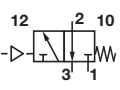
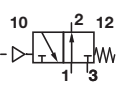
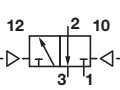
Symbol	Anschluss	Funktion	Betätigung/ Rückstellung	Durchfluss (l/min)	Betriebsdruck (bar)	Steuerdruck extern (bar)	Gewicht (kg)	Zeichnung Nr.	Typ
	G1/8	NC	Druckluft/Feder	750	-0,9 ... 10	2,5 ... 10	0,13	31	V60A4D7A-XA090
	G1/4	NC	Druckluft/Feder	1300	-0,9 ... 10	2,5 ... 10	0,21	31	V61B4D7A-XA090
	G3/8	NC	Druckluft/Feder	2600	-0,9 ... 10	2,5 ... 10	0,43	33	V62C4D7A-XA090
	G1/2	NC	Druckluft/Feder	4500	-0,9 ... 16	3 ... 16	0,75	35	V63D4D7A-XA090
	G1/8	NO	Druckluft/Feder	750	-0,9 ... 10	2,5 ... 10	0,13	32	V60A3D7A-XA090
	G1/4	NO	Druckluft/Feder	1300	-0,9 ... 10	2,5 ... 10	0,21	32	V61B3D7A-XA090
	G3/8	NO	Druckluft/Feder	2600	-0,9 ... 10	2,5 ... 10	0,43	34	V62C3D7A-XA090
	G1/2	NO	Druckluft/Feder	4500	-0,9 ... 16	3 ... 16	0,75	36	V63D3D7A-XA090
	G1/8	-	Druckluft/Druckluft	750	-0,9 ... 10	1,5 ... 10	0,13	37	V60A4DDA-XA020
	G1/4	-	Druckluft/Druckluft	1300	-0,9 ... 10	1,5 ... 10	0,21	37	V61B4DDA-XA020
	G3/8	-	Druckluft/Druckluft	2600	-0,9 ... 10	1,5 ... 10	0,43	38	V62C4DDA-XA020
	G1/2	-	Druckluft/Druckluft	4500	-0,9 ... 16	1,5 ... 16	0,68	39	V63D4DDA-XA020

2 x 3/2-Wegeventile, pneumatisch betätigt

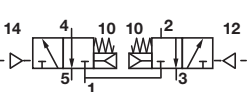
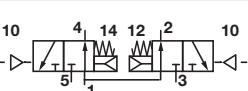
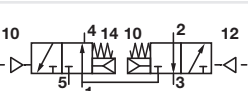
Symbol	Anschluss	Funktion	Betätigung/ Rückstellung	Durchfluss (l/min)	Betriebsdruck (bar)	Steuerdruck extern (bar)	Gewicht (kg)	Zeichnung Nr.	Typ
	G1/8	NC/NC	Druckluft/Druckluft	500	2 ... 10	2 ... 10	0,18	43	V60AADDA-XA020
	G1/4	NC/NC	Druckluft/Druckluft	950	2 ... 10	2 ... 10	0,28	43	V61BADDA-XA020
	G3/8	NC/NC	Druckluft/Druckluft	1900	2 ... 10	2 ... 10	0,60	44	V62CADDA-XA020
	G1/8	NO/NO	Druckluft/Druckluft	500	2 ... 10	2 ... 10	0,18	43	V60ABDDA-XA020
	G1/4	NO/NO	Druckluft/Druckluft	950	2 ... 10	2 ... 10	0,28	43	V61BBDDA-XA020
	G3/8	NO/NO	Druckluft/Druckluft	1900	2 ... 10	2 ... 10	0,60	44	V62CBDDA-XA020
	G1/8	NO/NC	Druckluft/Druckluft	500	2 ... 10	2 ... 10	0,18	43	V60ACDDA-XA020
	G1/4	NO/NC	Druckluft/Druckluft	950	2 ... 10	2 ... 10	0,28	43	V61BCDDA-XA020
	G3/8	NO/NC	Druckluft/Druckluft	1900	2 ... 10	2 ... 10	0,60	44	V62CCDDA-XA020

5/2-Wegeventile, pneumatisch betätigt

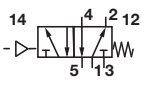
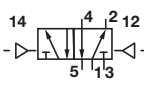
Symbol	Anschluss	Betätigung/ Rückstellung	Durchfluss (l/min)	Betriebsdruck (bar)	Steuerdruck extern (bar)	Gewicht (kg)	Zeichnung Nr.	Typ
	G1/8	Druckluft/Feder	750	-0,9 ... 10	2,5 ... 10	0,16	40	V60A5D7A-XA090
	G1/4	ADruckluft/Feder	1300	-0,9 ... 10	2,5 ... 10	0,26	40	V61B5D7A-XA090
	G3/8	Druckluft/Feder	2600	-0,9 ... 10	2,5 ... 10	0,56	41	V62C5D7A-XA090
	G1/2	Druckluft/Feder	4500	-0,9 ... 16	3 ... 16	0,92	42	V63D5D7A-XA090
	G1/8	Druckluft/Druckluft	750	-0,9 ... 10	1,5 ... 10	0,17	43	V60A5DDA-XA020
	G1/4	Druckluft/Druckluft	1300	-0,9 ... 10	1,5 ... 10	0,27	43	V61B5DDA-XA020
	G3/8	Druckluft/Druckluft	2600	-0,9 ... 10	1,5 ... 10	0,58	44	V62C5DDA-XA020
	G1/2	Druckluft/Druckluft	4500	-0,9 ... 16	1,5 ... 16	0,87	45	V63D5DDA-XA020

5/3-Wegeventile, pneumatisch betätigt

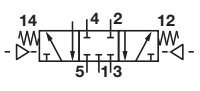
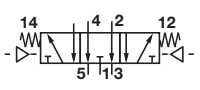
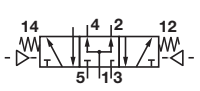
Symbol	Anschluss	Funktion	Betätigung/ Rückstellung	Durchfluss (l/min)	Betriebsdruck (bar)	Steuerdruck extern (bar)	Gewicht (kg)	Zeichnung Nr.	Typ
	G1/8	APB	Druckluft/Druckluft	500	-0,9 ... 10	3 ... 10	0,20	46	V60A6DDA-XA020
	G1/4	APB	Druckluft/Druckluft	950	-0,9 ... 10	3 ... 10	0,32	46	V61B6DDA-XA020
	G3/8	APB	Druckluft/Druckluft	1900	-0,9 ... 10	3 ... 10	0,67	47	V62C6DDA-XA020
	G1/2	APB	Druckluft/Druckluft	2300	-0,9 ... 10	3 ... 10	1,10	48	V63D6DDA-XA020
	G1/8	COE	Druckluft/Druckluft	500	-0,9 ... 10	3 ... 10	0,20	46	V60A7DDA-XA020
	G1/4	COE	Druckluft/Druckluft	950	-0,9 ... 10	3 ... 10	0,32	46	V61B7DDA-XA020
	G3/8	COE	Druckluft/Druckluft	1900	-0,9 ... 10	3 ... 10	0,67	47	V62C7DDA-XA020
	G1/2	COE	Druckluft/Druckluft	2300	-0,9 ... 10	3 ... 10	1,10	48	V63D7DDA-XA020
	G1/8	COP	Druckluft/Druckluft	500	-0,9 ... 10	3 ... 10	0,20	46	V60A8DDA-XA020
	G1/4	COP	Druckluft/Druckluft	950	-0,9 ... 10	3 ... 10	0,32	46	V61B8DDA-XA020
	G3/8	COP	Druckluft/Druckluft	1900	-0,9 ... 10	3 ... 10	0,67	47	V62C8DDA-XA020

NC = Sperr-Nullstellung

NO = Durchfluss-Nullstellung

NC/NC = Beide Ventile in Ruhestellung geschlossen (Anschluss P)

NO/NO = Beide Ventile in Ruhestellung geöffnet (Anschluss P)

SNO/NC = Ventil in Ruhestellung geöffnet, 1 Ventil in Ruhestellung geschlossen (Anschluss P)

APB = All ports blocked – in Mittelstellung alle Anschlüsse gesperrt

COE = Centre open exhaust – in Mittelstellung Anschluss 2+4 entlüftet

COP = Centre open pressure – in Mittelstellung Anschluss 2+4 belüftet

**Typenschlüssel
(elektropneumatisch betätigte
Ventile)**
V6***A-A*******

Gewinde	Kennung
G1/8	0A
G1/4	1B
G3/8	2C
G1/2	3D
NPT-Gewinde	Kennung
1/8 NPT	0P
1/4 NPT	1R
3/8 NPT	2S
1/2 NPT	3T
Funktion	Kennung
3/2 - NO	3
3/2 - NC	4
5/2	5
5/3 - APB	6
5/3 - COE	7
5/3 - COP	8
2 x 3/2 - NC	A
2 x 3/2 - NO	B
2 x 3/2 - NO/NC	C



Steckerbild	Kennung	
22 mm, Industriestandard	J	
22 mm, DIN EN 175301-803 (DIN 43650), Form B	L	
Spannung	Kennung	
12 V d.c. 2 W	12	
24 V d.c. 2 W	13	
24 V a.c. (50/60 Hz) 4/2,5 VA	14	
110/120 V a.c. (50/60 Hz) 4/2,5 VA	18	
220/240 V a.c. (50/60 Hz) 6/5 VA	19	
Handhilfsbetätigung	Kennung	
Ohne	1	
Drücken, arretierbar	2	
Drücken, nicht arretierbar	3	
Betätigung/ Rückstellung	Steuer- luft	v
E.magnet/E.magnet	Intern	11
E.magnet/Luftfeder	Intern	13
E.magnet/Feder	Intern	17
E.magnet/E.magnet/	Extern	22
E.magnet/Luftfeder	Extern	23
E.magnet/Feder	Extern	27

**Typenschlüssel
(pneumatisch betätigte
Ventile)**
V6*D*A-X***0**

Gewinde	Kennung
G1/8	0A
G1/4	1B
G3/8	2C
G1/2	3D
NPT-Gewinde	Kennung
1/8 NPT	0P
1/4 NPT	1R
3/8 NPT	2S
1/2 NPT	3T
Funktion	Kennung
3/2 - NO	3
3/2 - NC	4
5/2	5
5/3 - APB	6
5/3 - COE	7
5/3 - COP	8
2 x 3/2 - NC	A
2 x 3/2 - NO	B
2 x 3/2 - NO/NC	C

Betätigung/Rückstellung	Kennung
Druckluft/Druckluft	02
Druckluft/Feder	09
Steuerluftanschluss	Kennung
G1/8	A
1/8 NPT	P
Betätigung/Rückstellung	Kennung
Druckluft/Druckluft	D
Druckluft/Feder	7

Sammelleisten für gemeinsame Druckversorgung (V60 und V61) - bevorzugt für 3/2 Ventile

	Sammelleiste* 2 ... 9 Ventilplätze	10 und 12 Ventilplätze	Winkel für Sammelleiste	Verschlussstück für nicht benötigte Ventilplätze
				
Serie	Seite 19	Seite 19	Seite 19	
V60	263962 *1)	263963 *2)	0555485	0491586
V61	263942 *1)	263943 *2)	0555484	0491587

* komplett mit Hohlschrauben und Dichtungen





*1) Bitte ergänzen Sie den Typ um die Anzahl der Ventilplätze: 2, 3, 4, 5, 6, 7 und 8

*2) Bitte ergänzen Sie den Typ um die Anzahl der Ventilplätze: 9 (nur für V61), 0 für 10 und 2 für 12

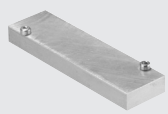

Sammelgrundplatten - erhältlich für 2 x 3/2-, 5/2-, 5/3-Ventile

	Ventilplätze 2	3	4	6	12
					
Serie	Seite 17	Seite 17	Seite 17	Seite 17	Seite 17
V60	2221002	2221003	2221004	2221006	2221012
V61	2221102	2221103	2221104	2221106	2221112
V62	2221202	2221203	2221204	2221206	2221212

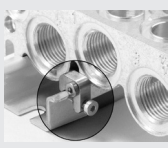
Zubehör für Sammelgrundplatte

	Blindplatte	Stopfen für 2- und 3-fach-Platten	Druckabspernteil für Anschluss 1	Druckabspernteil für Anschluss 3 oder 5	Befestigungssatz für DIN-Schiene
					
Serie			Seite 17	Seite 17	Seite 18
V60	0100561	0701208	0100567	0110236	0101796
V61	0100563	0701209	0100569	0110237	0101796
V62	0100565	0701210	0100571	0110238	0101796

Zubehör für Magnetspule

Diffusor für Vorsteuerent- lüftung	Halteclip für Magnet- befestigung
	
81110800	81021600

Abmessungen

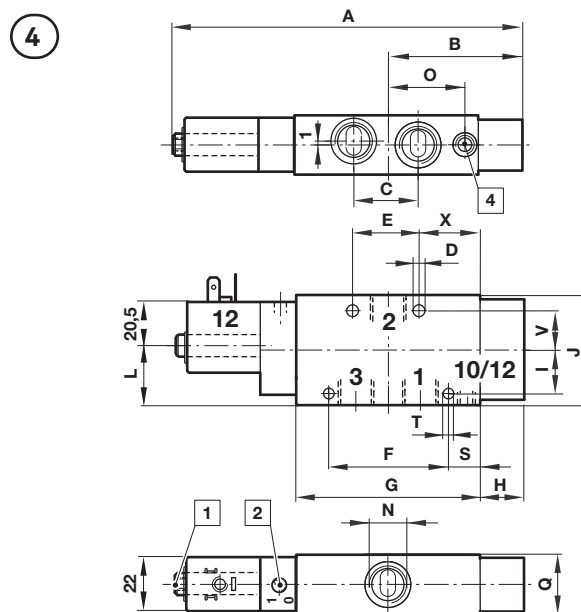
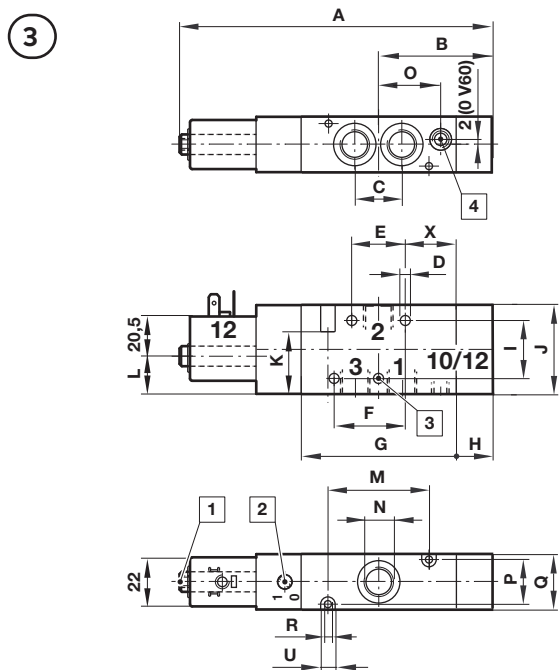
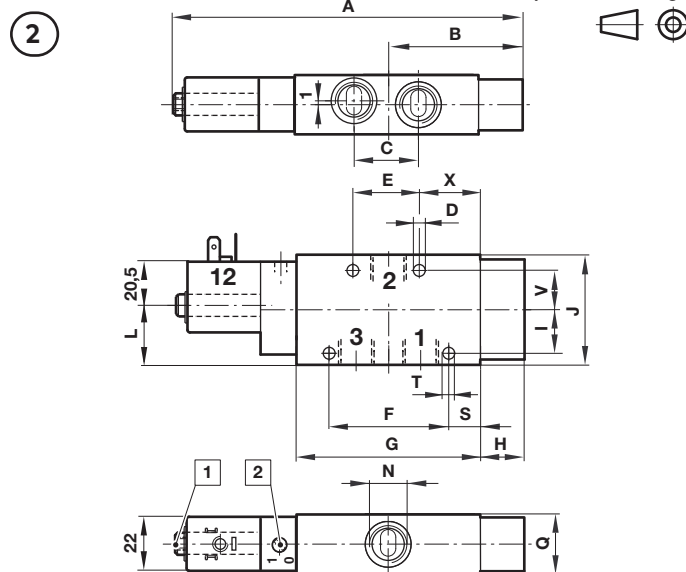
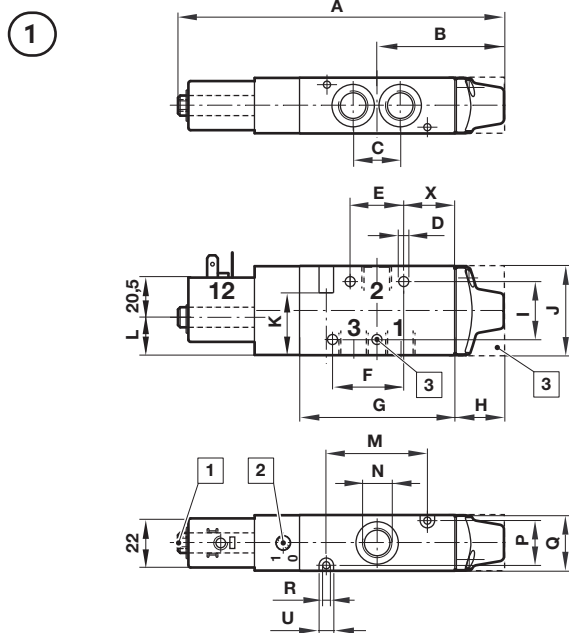
 Abmessungen in mm
 Projection/First angle

1 Gefasste Spulenteilung (M5)

2 Handhilfsbetätigung

3 V62: Nur zentrale Befestigungsbohrung (ohne linke Bohrung) und rechteckigem Enddeckel

4 Externer Steuerluftanschluss, M5 oder 10-32 UNF (V60, V61 & V62), G1/8 oder 1/8-27 NPT (V63)

Nr.	A	B	C	ØD	E	F	G	H	I	J	K	L	M	N	O	P	Q	ØR	S	ØT	ØU	V	X	Typ
1	125	45	16	4,5	18	25	56	17	26	35	28	12	35	G1/8	—	17	22	3,2	—	—	6,5	—	19	V60A417A—...
1	147	57,5	21	4,5	24	32	70	22,5	26	40	28	17	46	G1/4	—	20	25	3,2	—	—	6,5	—	23	V61B417A—...
1	166,5	70	24,5	4,5	26	—	83,5	28	36	55	44	32	54	G3/8	—	28	34	4,5	—	—	8,0	23	30	V62C417A—...
2	197	87,5	38	7	46	75	108	33,5	26	65	—	38	—	G1/2	—	—	35	—	18,5	5,5	—	—	36	V63D417A—...
3	116,5	37	16	4,5	18	25	56	9	26	35	28	12	35	G1/8	—	17	22	3,2	—	—	6,5	—	19	V60A413A—...
3	132,5	43	21	4,5	24	32	70	8	26	40	28	17	46	G1/4	—	20	25	3,2	—	—	6,5	—	23	V61B413A—...
3	147	50,5	24,5	4,5	26	—	83,5	9	36	55	44	32	54	G3/8	—	28	34	4,5	—	—	8,0	—	30	V62C413A—...
3	116,5	37	16	4,5	18	25	56	9	26	35	28	12	35	G1/8	22	17	22	3,2	—	—	6,5	—	19	V60A423A—...
3	132,5	43	21	4,5	24	32	70	8	26	40	28	17	46	G1/4	29	20	25	3,2	—	—	6,5	—	23	V61B423A—...
3	147	50,5	24,5	4,5	26	—	83,5	9	36	55	44	32	54	G3/8	—	28	34	4,5	—	—	8,0	—	30	V62C423A—...
4	190	80	38	7,0	46	75	108	26	26	65	—	38	—	G1/2	—	—	35	—	18,5	5,5	—	23	36	V63D413A—...
4	190	80	38	7,0	46	75	108	26	26	65	—	38	—	G1/2	45	—	35	—	18,5	5,5	—	23	36	V63D423A—...

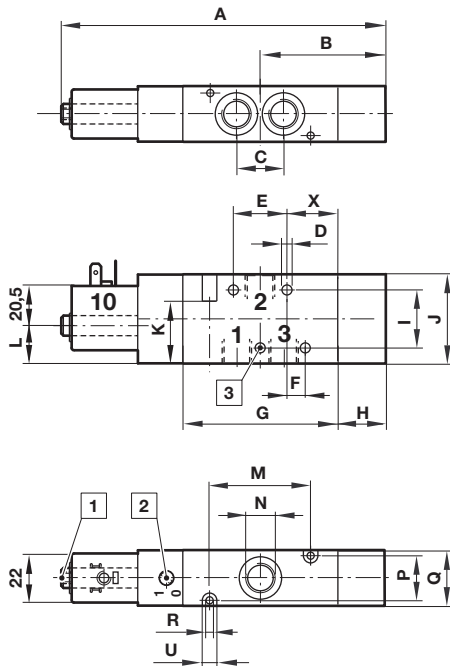
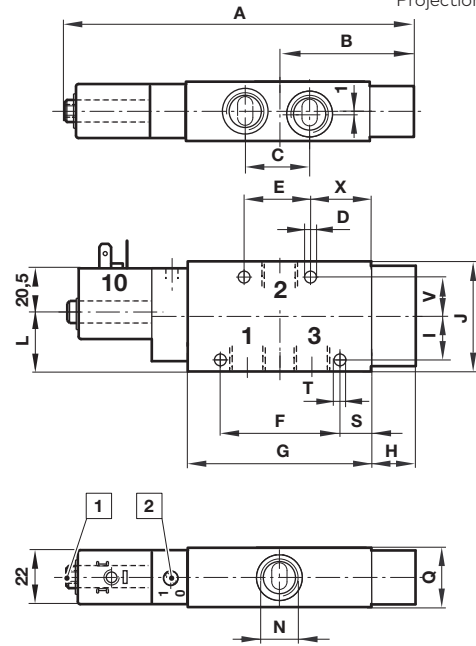
5

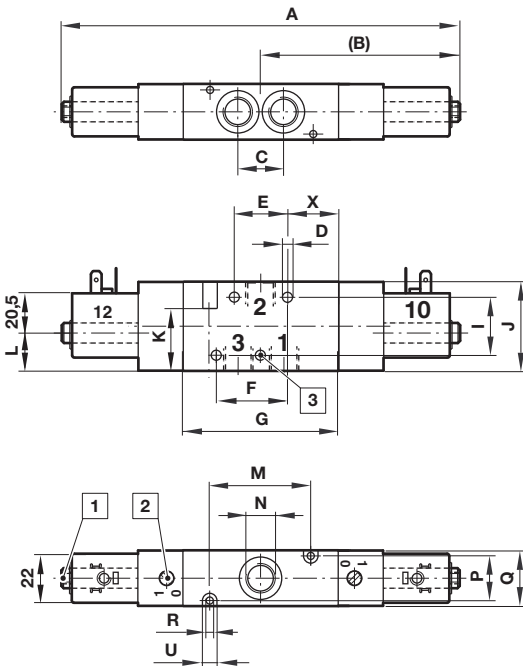
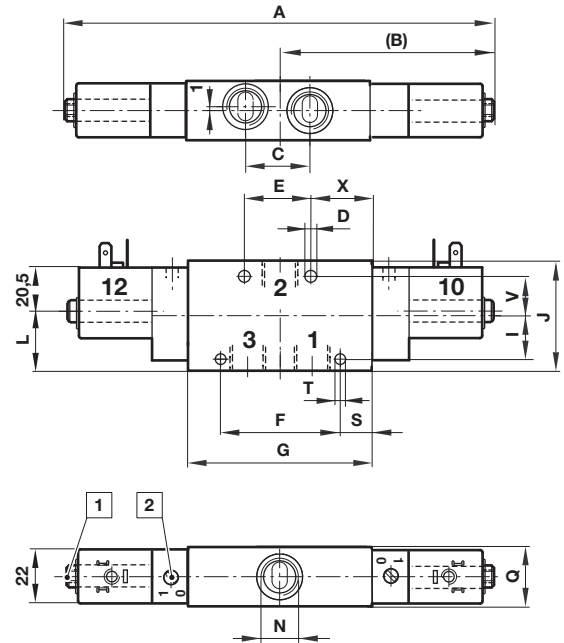
6

 Abmessungen in mm
 Projection/First angle

7

8

1 Gefasste Spulentrüftung (M5)

2 Handhilfsbetätigung

3 V62: Nur zentrale Befestigungsbohrung (ohne linke Bohrung) und rechteckigem Enddeckel

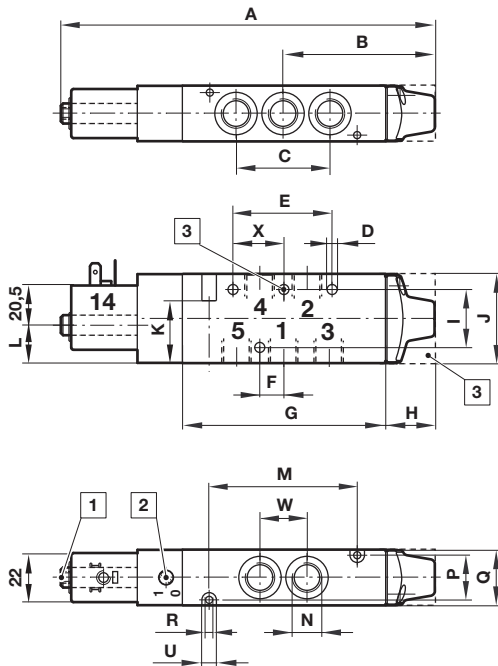
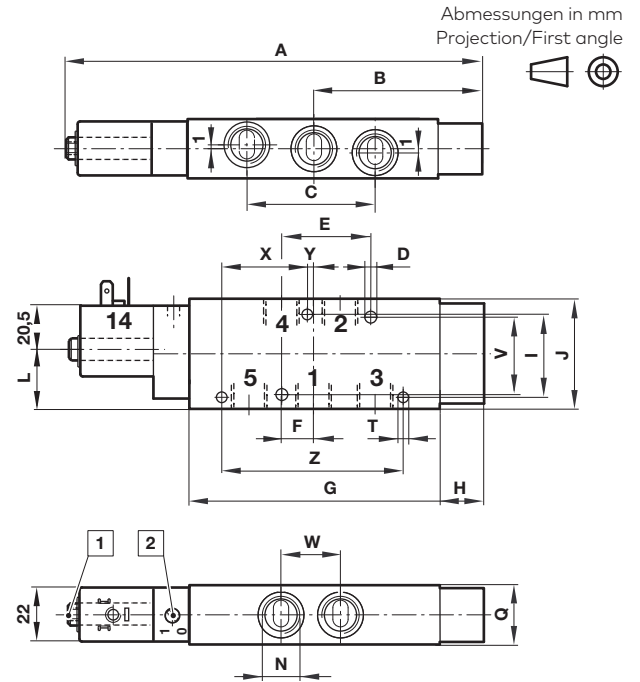
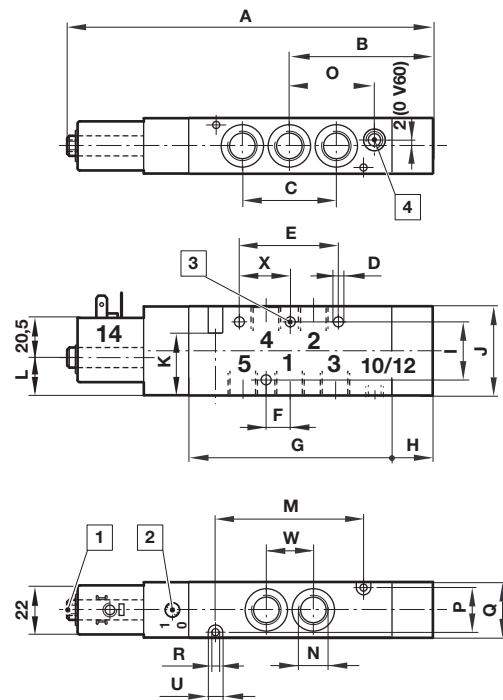
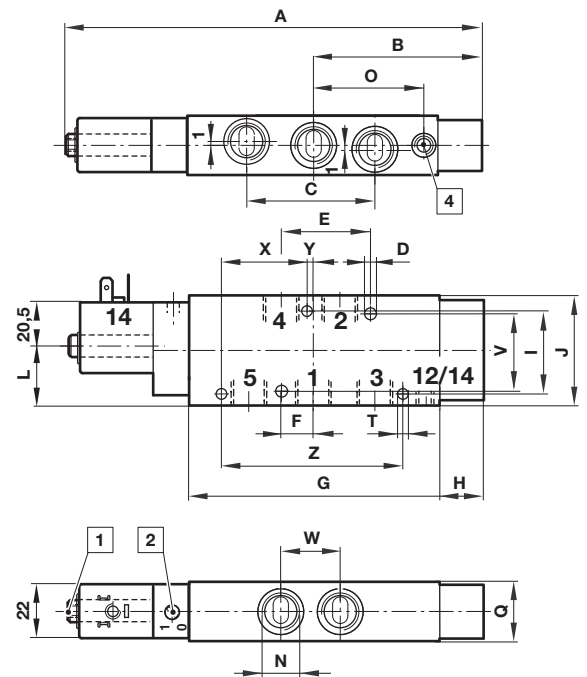
4 Externer Steuerluftanschluss, M5 oder 10-32 UNF (V60 & V61), G1/8 oder 1/8-27 NPT

Nr.	A	B	C	ØD	E	F	G	H	I	J	K	L	M	N	P	Q	ØR	S	ØT	ØU	V	X	Typ
5	116,5	37	16	4,5	18	7	56	9	26	35	28	12	35	G1/8	17	22	3,2	—	—	6,5	—	19	V60A313A—...
5	132,5	43	21	4,5	24	8	70	8	26	40	28	17	46	G1/4	20	25	3,2	—	—	6,5	—	23	V61B313A—...
5	147	50,5	24,5	4,5	26	—	83,5	9	36	55	44	32	54	G3/8	28	34	4,5	—	—	8,0	—	28	V62C313A—...
6	190	80	38	7,0	46	75	108	26	26	65	—	38	—	G1/2	—	35	—	14,5	5,5	—	23	26	V63D313A—...
7	159,5	79,5	16	4,5	18	25	56	—	26	35	28	12	35	G1/8	17	22	3,2	—	—	6,5	—	19	V60A411A—...
7	179	89,5	21	4,5	24	32	70	—	26	40	28	17	46	G1/4	20	25	3,2	—	—	6,5	—	23	V61B411A—...
7	193,5	97	24,5	4,5	26	—	83,5	—	36	55	44	32	54	G3/8	28	34	4,5	—	—	8,0	—	30	V62C411A—...
8	219	109,5	38	7,0	46	75	108	—	26	65	—	38	—	G1/2	—	35	—	18,5	5,5	—	23	36	V63D411A—...

9

10

11

12

1 Gefasste Spulentrüftung (M5)

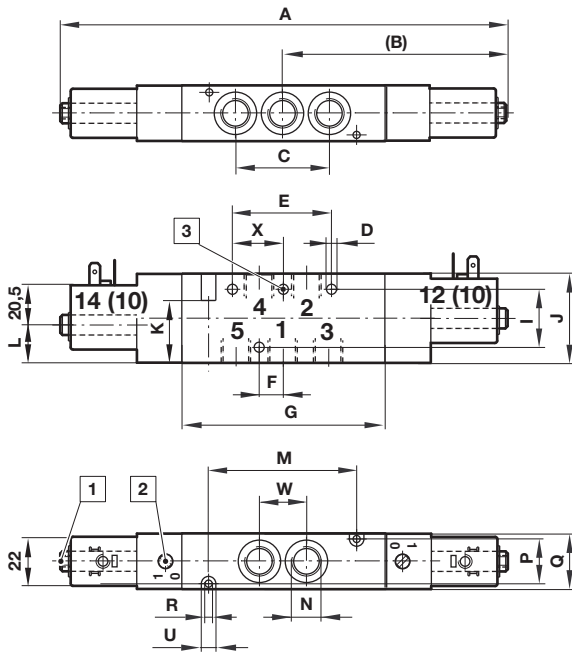
2 Handhilfsbetätigung

3 V62: Nur zentrale Befestigungsbohrung (ohne linke Bohrung) und rechteckigem Enddeckel

4 Externer Steuerluftanschluss, M5 oder 10-32 UNF (V60, V61 & V62), G1/8 oder 1/8-27 NPT (V63)

Nr.	A	B	C	ØD	E	F	G	H	I	J	K	L	M	N	O	P	Q	ØR	ØT	ØU	V	W	X	Y	Z	Typ
9	140	52,5	32,5	4,5	33,5	8	71	17	26	35	28	12	50	G1/8	—	17	22	3,2	—	6,5	—	16	17	—	—	V60A517A—...
9	167	67,5	42	4,5	44	10	90	22,5	26	40	28	17	66	G1/4	—	20	25	3,2	—	6,5	—	21	22	—	—	V61B517A—...
9	191	82	49	4,5	—	12	108	28	36	55	44	32	78	G3/8	—	28	34	4,5	—	8,0	—	24,5	26	—	—	V62C517A—...
10	235	106,5	76	7,0	60	19	146	33,5	52	65	—	38	—	G1/2	—	—	35	—	5,5	—	46	38	57,5	3	115	V63D517A—...
11	132	44,5	32,5	4,5	33,5	8	71	9	26	35	28	12	50	G1/8	—	17	22	3,2	—	6,5	—	16	17	—	—	V60A513A—...
11	153	53	42	4,5	44	10	90	8	26	40	28	17	66	G1/4	—	20	25	3,2	—	6,5	—	21	22	—	—	V61B513A—...
11	171,5	62,5	49	4,5	—	12	108	8,5	36	55	44	32	78	G3/8	—	28	34	4,5	—	8,0	—	24,5	26	—	—	V62C513A—...
12	228	99	76	7,0	60	19	146	26	52	65	—	38	—	G1/2	—	—	35	—	5,5	—	46	38	57,5	3	115	V63D513A—...
11	132	44,5	32,5	4,5	33,5	8	71	9	26	35	28	12	50	G1/8	29,5	17	22	3,2	—	6,5	—	16	17	—	—	V60A523A—...
11	153	53	42	4,5	44	10	90	8	26	40	28	17	66	G1/4	39	20	25	3,2	—	6,5	—	21	22	—	—	V61B523A—...
11	171,5	62,5	49	4,5	—	12	108	8,5	36	55	44	32	78	G3/8	48	28	34	4,5	—	8,0	—	24,5	26	—	—	V62C523A—...
12	228	99	76	7,0	60	19	146	26	52	65	—	38	—	G1/2	64	—	35	—	5,5	—	46	38	57,5	3	115	V63D523A—...

13

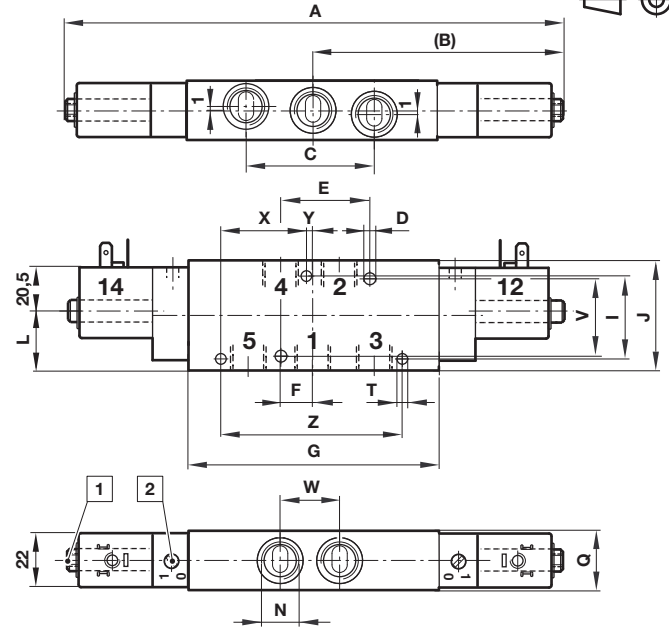
14

 Abmessungen in mm
 Projection/First angle

- 1** Gefasste Spulentrüftung (M5)
- 2** Handhilfsbetätigung
- 3** V62: Nur zentrale Befestigungsbohrung (ohne linke Bohrung)

Nr.	A	B	C	ØD	E	F	G	I	J	K	L	M	N	P	Q	ØR	ØT	ØU	V	W	X	Y	Z	Typ
13	174,5	87,5	32,5	4,5	33,5	8	71	26	35	28	12	50	G1/8	17	22	3,2	—	6,5	—	16	17	—	—	V60A511A—...
13	174,5	87,5	32,5	4,5	33,5	8	71	26	35	28	12	50	G1/8	17	22	3,2	—	6,5	—	16	17	—	—	V60AA11A—...
13	174,5	87,5	32,5	4,5	33,5	8	71	26	35	28	12	50	G1/8	17	22	3,2	—	6,5	—	16	17	—	—	V60AB11A—...
13	174,5	87,5	32,5	4,5	33,5	8	71	26	35	28	12	50	G1/8	17	22	3,2	—	6,5	—	16	17	—	—	V60AC11A—...
13	199	99,5	42	4,5	44	10	90	26	40	28	17	66	G1/4	20	25	3,2	—	6,5	—	21	22	—	—	V61B511A—...
13	199	99,5	42	4,5	44	10	90	26	40	28	17	66	G1/4	20	25	3,2	—	6,5	—	21	22	—	—	V61BA11A—...
13	199	99,5	42	4,5	44	10	90	26	40	28	17	66	G1/4	20	25	3,2	—	6,5	—	21	22	—	—	V61BB11A—...
13	199	99,5	42	4,5	44	10	90	26	40	28	17	66	G1/4	20	25	3,2	—	6,5	—	21	22	—	—	V61BC11A—...
13	218	109	49	4,5	—	12	108	36	55	44	32	78	G3/8	28	34	4,5	—	8,0	—	24,5	26	—	—	V62C511A—...
13	218	109	49	4,5	—	12	108	36	55	44	32	78	G3/8	28	34	4,5	—	8,0	—	24,5	26	—	—	V62CA11A—...
13	218	109	49	4,5	—	12	108	36	55	44	32	78	G3/8	28	34	4,5	—	8,0	—	24,5	26	—	—	V62CB11A—...
13	218	109	49	4,5	—	12	108	36	55	44	32	78	G3/8	28	34	4,5	—	8,0	—	24,5	26	—	—	V62CC11A—...
14	257	128,5	76	7,0	60	19	146	52	65	—	38	—	G1/2	—	35	—	5,5	—	46	38	57,5	3	115	V63D511A—...

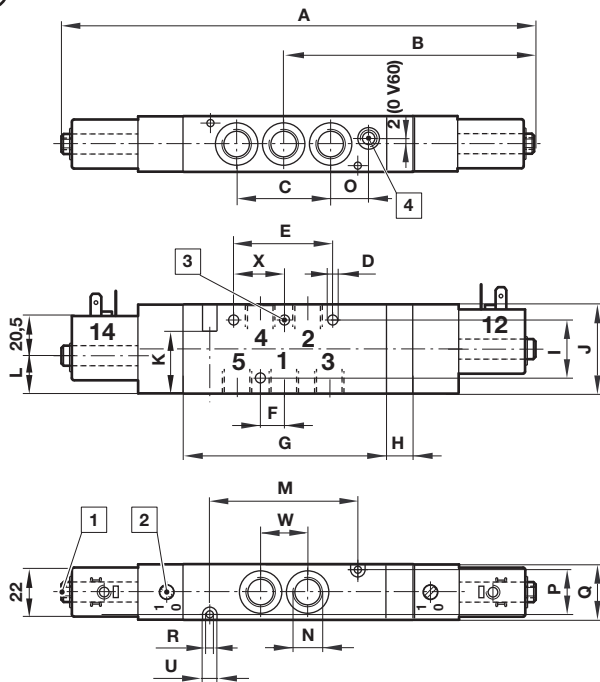
15

 Abmessungen in mm
 Projection/First angle

- 1 Gefasste Spulenentlüftung (M5)
- 2 Handhilfsbetätigung
- 3 V62: Nur zentrale Befestigungsbohrung (ohne linke Bohrung) und rechteckigem Enddeckel
- 4 Externer Steuerluftanschluss, M5 oder 10-32 UNF (V60 & V61), G1/8 oder 1/8-27 NPT (V60, V61 & V62)

Nr..	A	B	C	ØD	E	F	G	H	I	J	K	L	M	N	O	P	Q	ØR	ØU	W	X	Typ
15	188,5	101,5	32,5	4,5	33,5	8	71	14	26	35	28	12	50	G1/8	13	17	22	3,2	6,5	16	17	V60A611A—...
15	188,5	101,5	32,5	4,5	33,5	8	71	14	26	35	28	12	50	G1/8	13	17	22	3,2	6,5	16	17	V60A622A—...
15	188,5	101,5	32,5	4,5	33,5	8	71	14	26	35	28	12	50	G1/8	13	17	22	3,2	6,5	16	17	V60A711A—...
15	188,5	101,5	32,5	4,5	33,5	8	71	14	26	35	28	12	50	G1/8	13	17	22	3,2	6,5	16	17	V60A722A—...
15	188,5	101,5	32,5	4,5	33,5	8	71	14	26	35	28	12	50	G1/8	13	17	22	3,2	6,5	16	17	V60A811A—...
15	188,5	101,5	32,5	4,5	33,5	8	71	14	26	35	28	12	50	G1/8	13	17	22	3,2	6,5	16	17	V60A822A—...
15	217	117,5	42	4,5	44	10	90	18	26	40	28	17	66	G1/4	18	20	25	3,2	6,5	21	22	V61B611A—...
15	217	117,5	42	4,5	44	10	90	18	26	40	28	17	66	G1/4	18	20	25	3,2	6,5	21	22	V61B622A—...
15	217	117,5	42	4,5	44	10	90	18	26	40	28	17	66	G1/4	18	20	25	3,2	6,5	21	22	V61B711A—...
15	217	117,5	42	4,5	44	10	90	18	26	40	28	17	66	G1/4	18	20	25	3,2	6,5	21	22	V61B722A—...
15	217	117,5	42	4,5	44	10	90	18	26	40	28	17	66	G1/4	18	20	25	3,2	6,5	21	22	V61B811A—...
15	217	117,5	42	4,5	44	10	90	18	26	40	28	17	66	G1/4	18	20	25	3,2	6,5	21	22	V61B822A—...
15	240,5	131,5	49	4,5	—	12	108	22,5	36	55	44	32	78	G3/8	23,5	28	34	4,5	8	24,5	26	V62C611A—...
15	240,5	131,5	49	4,5	—	12	108	22,5	36	55	44	32	78	G3/8	23,5	28	34	4,5	8	24,5	26	V62C622A—...
15	240,5	131,5	49	4,5	—	12	108	22,5	36	55	44	32	78	G3/8	23,5	28	34	4,5	8	24,5	26	V62C711A—...
15	240,5	131,5	49	4,5	—	12	108	22,5	36	55	44	32	78	G3/8	23,5	28	34	4,5	8	24,5	26	V62C722A—...
15	240,5	131,5	49	4,5	—	12	108	22,5	36	55	44	32	78	G3/8	23,5	28	34	4,5	8	24,5	26	V62C811A—...
15	240,5	131,5	49	4,5	—	12	108	22,5	36	55	44	32	78	G3/8	23,5	28	34	4,5	8	24,5	26	V62C811A—...

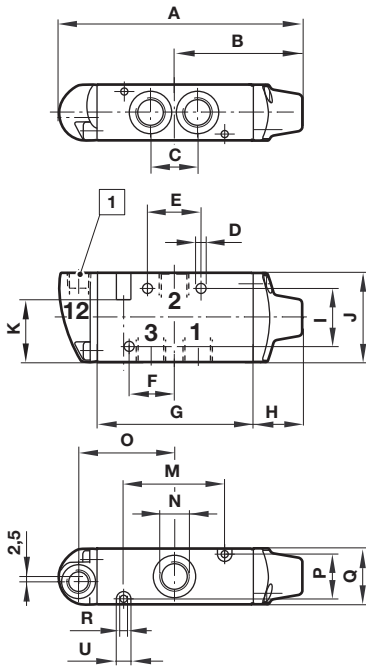
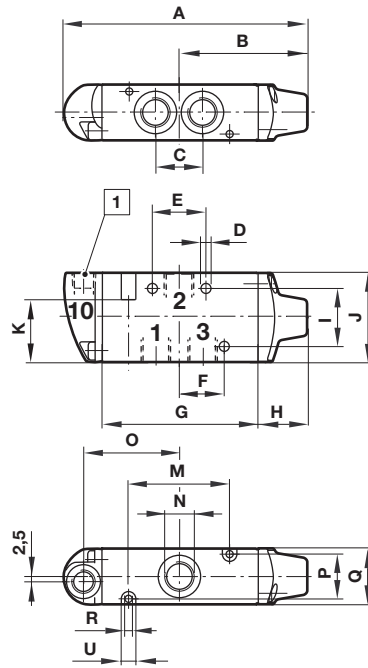
31

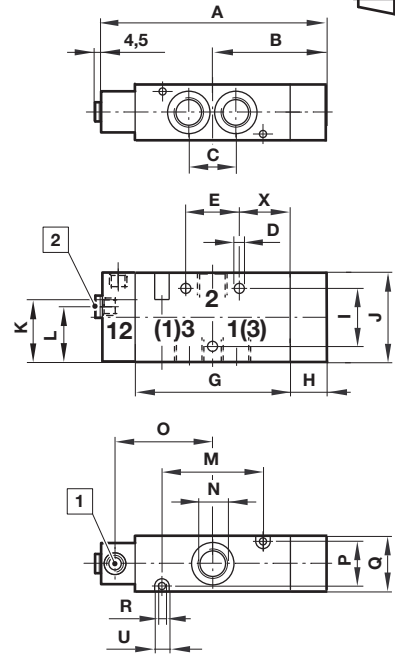
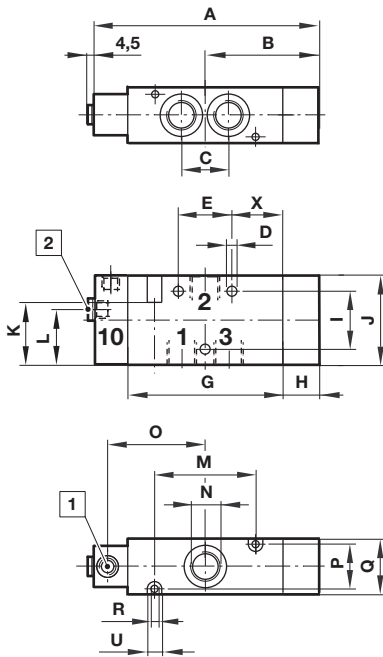
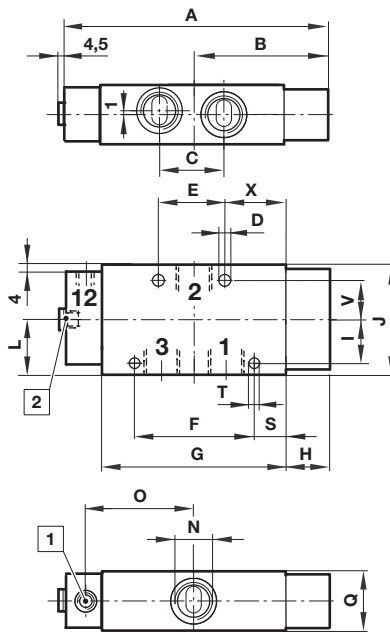
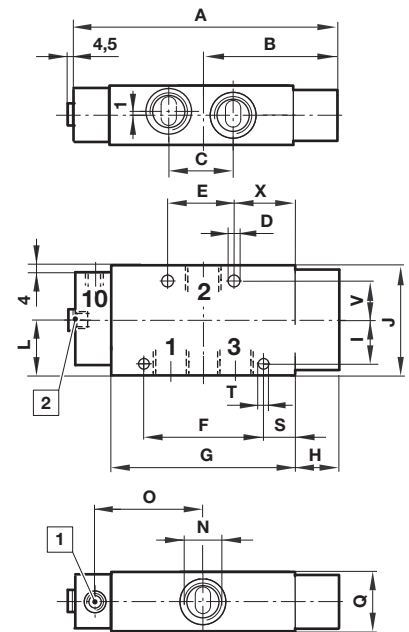
32

33

 Abmessungen in mm
 Projection/First angle

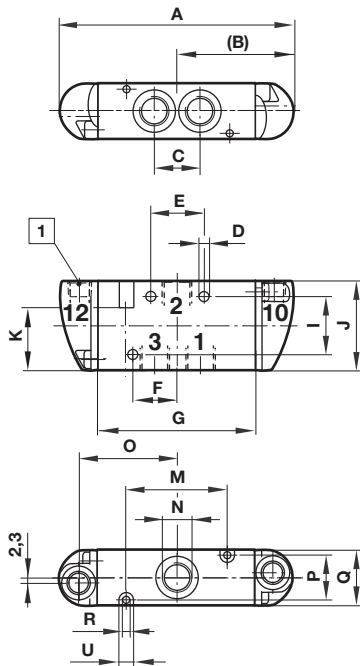
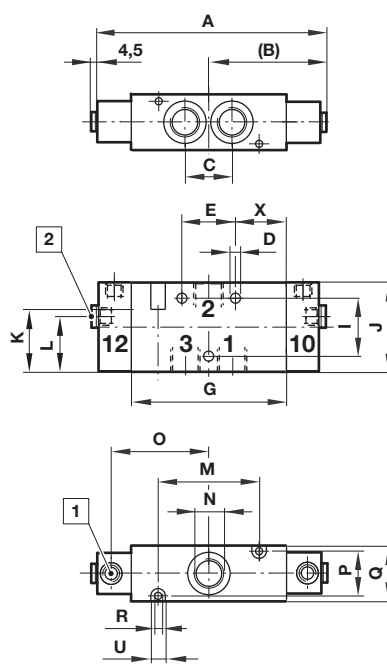
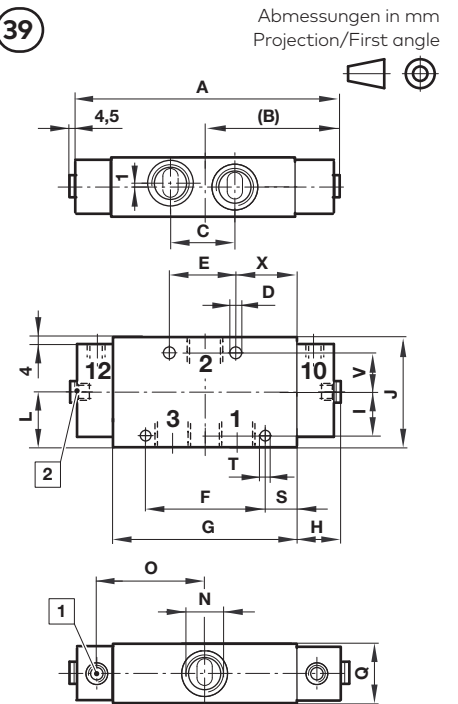
34

35

36

- 1** Steuerluftanschlüsse G1/8 oder 1/8-27 NPT
2 Alternative Steuerluftanschlüsse G1/8 oder 1/8-27 NPT

Nr.	A	B	C	ØD	E	F	G	H	I	J	K	L	M	N	O	P	Q	ØR	S	ØT	ØU	V	X	Typ	
31	89,5	45	16	4,5	18	16	56	17	26	35	28	-	35	G1/8	36	17	22	3,2	-	-	6,5	-	-	-	V60A4D7A-...
31	110	57,5	21	4,5	24	20	70	22,5	26	40	28	-	46	G1/4	43	20	25	3,2	-	-	6,5	-	-	-	V61B4D7A-...
32	89,5	45	16	4,5	18	16	56	17	26	35	28	-	35	G1/8	36	17	22	3,2	-	-	6,5	-	-	-	V60A3D7A-...
32	110	57,5	21	4,5	24	20	70	22,5	26	40	28	-	46	G1/4	43	20	25	3,2	-	-	6,5	-	-	-	V61B3D7A-...
33	132	70	24,5	4,5	26	-	83,5	28	36	55	-	33,5	54	G3/8	52	28	34	4,5	-	-	8,0	-	30	-	V62C4D7A-...
34	132	70	24,5	4,5	26	-	83,5	28	36	55	-	33,5	54	G3/8	52	28	34	4,5	-	-	8,0	-	28	-	V62C3D7A-...
35	162	87,5	38	7,0	46	75	108	33,5	26	65	-	39,5	-	G1/2	64	-	35	-	18,5	5,5	-	23	36	-	V63D4D7A-...
36	162	87,5	38	7,0	46	75	108	33,5	26	65	-	39,5	-	G1/2	64	-	35	-	14,5	5,5	-	23	26	-	V63D3D7A-...

37

38

39

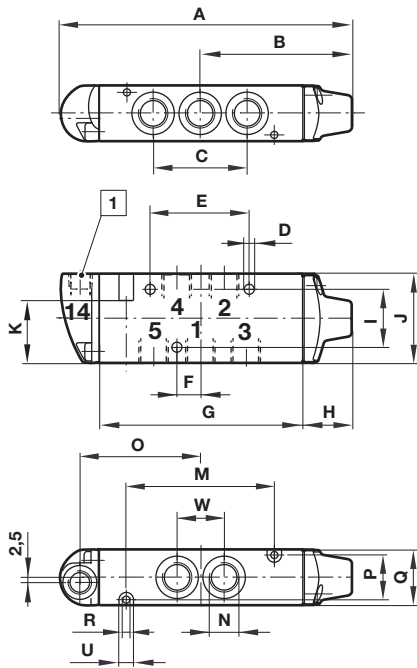
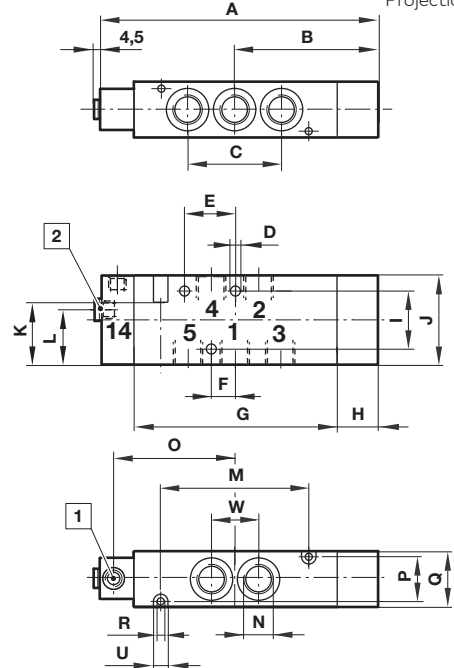
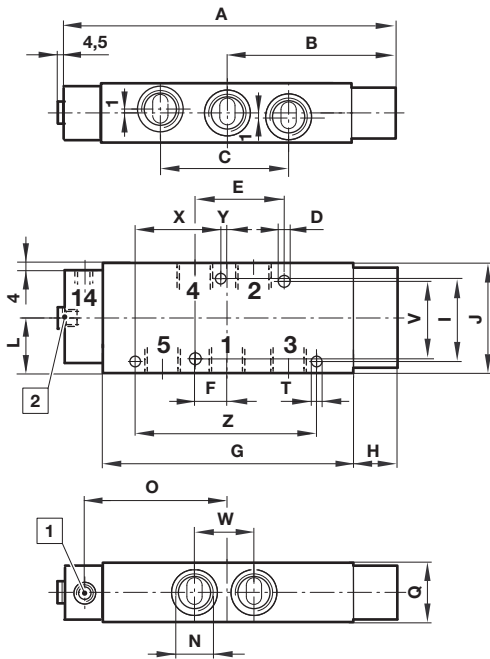
1 Steuerluftanschlüsse G1/8 oder 1/8-27 NPT

2 Alternative Steuerluftanschlüsse G1/8 oder 1/8-27 NPT

Nr..	A	B	C	D	E	F	G	I	J	K	L	M	N	O	P	Q	R	S	T	U	V	X	Typ
37	89	44,5	16	4,5	18	16	56	26	35	28	—	35	G1/8	36	17	22	3,2	—	—	6,5	—	—	V60A4DDA—...
37	104	52	21	4,5	24	20	70	26	40	28	—	46	G1/4	43	20	25	3,2	—	—	6,5	—	—	V61B4DDA—...
38	124	62	24,5	4,5	26	—	83,5	36	55	44	33,5	54	G3/8	52	28	34	4,5	—	—	8,0	—	30	V62C4DDA—...
39	148	74	38	7,0	46	75	108	26	65	—	39,5	—	G1/2	64	—	35	—	18,5	5,5	—	23	36	V63D4DDA—...

40

41

42

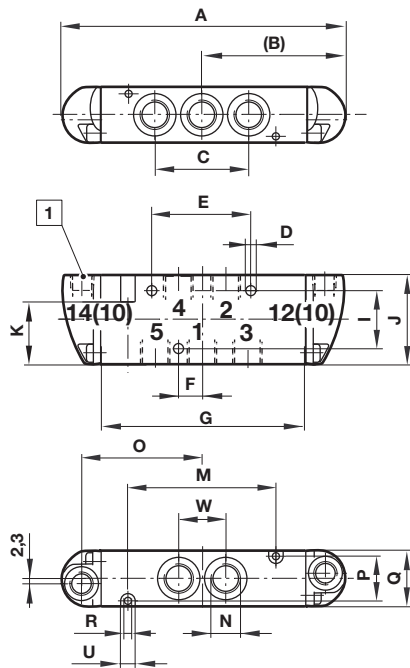
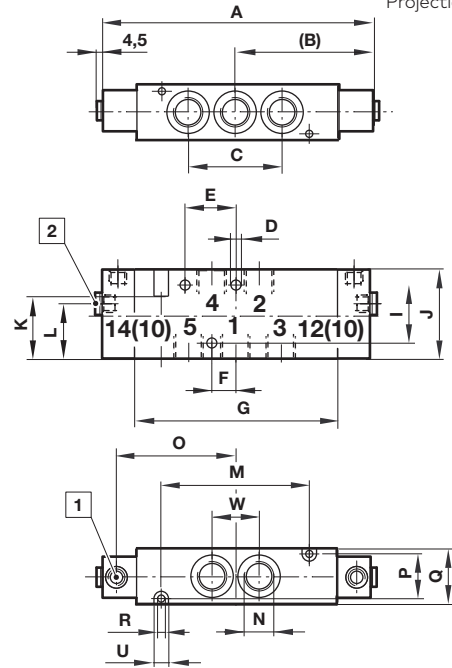
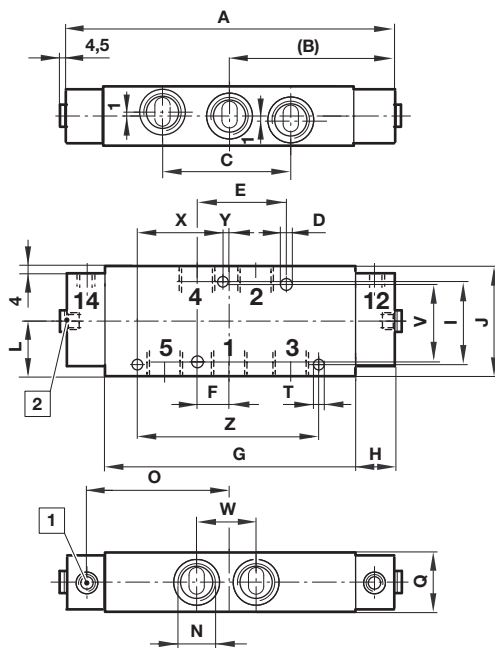
- 1 Steuerluftanschlüsse G1/8 oder 1/8-27 NPT
- 2 Alternative Steuerluftanschlüsse G1/8 oder 1/8-27 NPT

Nr.	A	B	C	D	E	F	G	H	I	J	K	L	M	N	O	P	Q	R	T	U	V	W	X	Y	Z	Typ	
40	105	52,5	32,5	4,5	33,5	8	71	17	26	35	28	—	50	G1/8	43,5	17	22	3,2	—	6,5	—	16	—	—	—	—	V60A5D7A—...
40	130	67,5	42	4,5	44	10	90	22,5	26	40	28	—	66	G1/4	53	20	25	3,2	—	6,5	—	21	—	—	—	—	V61B5D7A—...
41	156	82	49	4,5	26	12	108	28	36	55	44	33,5	78	G3/8	64	28	34	4,5	—	8,0	—	24,5	—	—	—	—	V62C5D7A—...
42	200	106,5	76	7,0	60	19	146	33,5	52	65	—	39,5	—	G1/2	83	—	35	—	5,5	—	46	38	57,5	3	115	V63D5D7A—...	

43

44

45

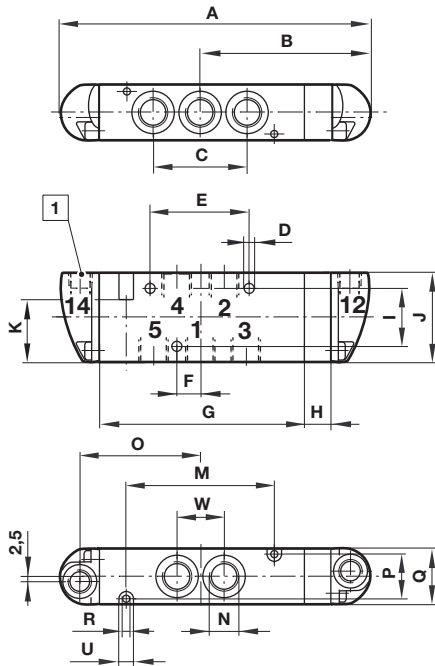
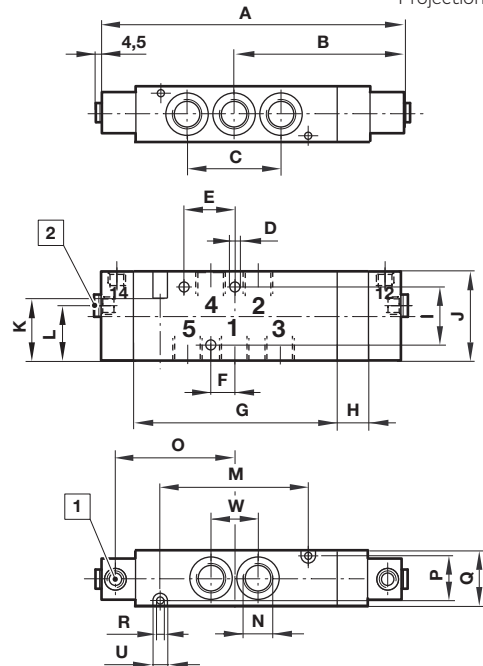
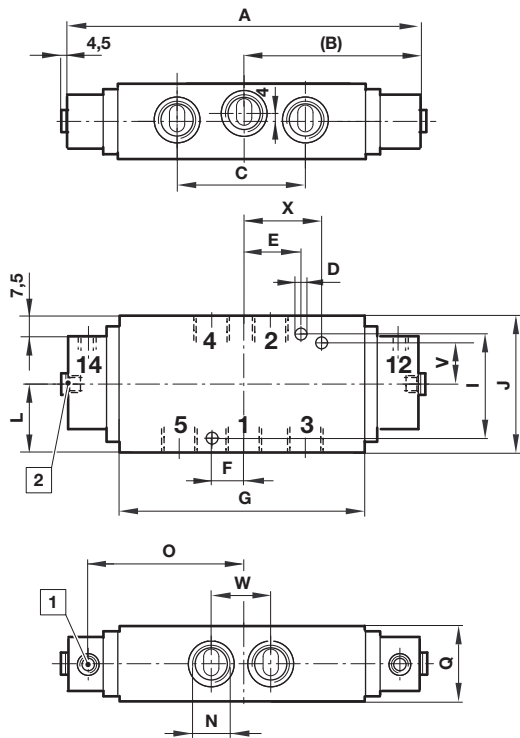
- 1 Steuerluftanschlüsse G1/8 oder 1/8-27 NPT
2 Alternative Steuerluftanschlüsse G1/8 oder 1/8-27 NPT

Nr.	A	B	C	D	E	F	G	H	I	J	K	L	M	N	O	P	Q	R	T	U	V	W	X	Z	Typ
43	104,5	52,5	32,5	4,5	33,5	8	71	—	26	35	28	—	50	G1/8	44	17	22	3,2	—	6,5	—	16	—	—	V60A5DDA—...
43	104,5	52,5	32,5	4,5	33,5	8	71	—	26	35	28	—	50	G1/8	44	17	22	3,2	—	6,5	—	16	—	—	V60AADDA—...
43	104,5	52,5	32,5	4,5	33,5	8	71	—	26	35	28	—	50	G1/8	44	17	22	3,2	—	6,5	—	16	—	—	V60ABDDA—...
43	104,5	52,5	32,5	4,5	33,5	8	71	—	26	35	28	—	50	G1/8	44	17	22	3,2	—	6,5	—	16	—	—	V60ACDDA—...
43	124	62	42	4,5	44	10	90	—	26	40	28	—	66	G1/4	53	20	25	3,2	—	6,5	—	21	—	—	V61B5DDA—...
43	124	62	42	4,5	44	10	90	—	26	40	28	—	66	G1/4	53	20	25	3,2	—	6,5	—	21	—	—	V61BADDA—...
43	124	62	42	4,5	44	10	90	—	26	40	28	—	66	G1/4	53	20	25	3,2	—	6,5	—	21	—	—	V61BBDDA—...
43	124	62	42	4,5	44	10	90	—	26	40	28	—	66	G1/4	53	20	25	3,2	—	6,5	—	21	—	—	V61BCDDA—...
44	148	74	49	4,5	26	12	108	—	36	55	44	33,5	78	G3/8	64	28	34	4,5	—	8,0	—	24,5	—	—	V62C5DDA—...
44	148	74	49	4,5	26	12	108	—	36	55	44	33,5	78	G3/8	64	28	34	4,5	—	8,0	—	24,5	—	—	V62CADDA—...
44	148	74	49	4,5	26	12	108	—	36	55	44	33,5	78	G3/8	64	28	34	4,5	—	8,0	—	24,5	—	—	V62CBDDA—...
44	148	74	49	4,5	26	12	108	—	36	55	44	33,5	78	G3/8	64	28	34	4,5	—	8,0	—	24,5	—	—	V62CCDDA—...
45	186	93	76	7,0	60	19	146	—	52	65	—	39,5	—	G1/2	83	—	35	—	5,5	—	46	38	57,5	115	V63D5DDA—...

46

47

48

- 1 Steuerluftanschlüsse G1/8 oder 1/8-27 NPT
- 2 Alternative Steuerluftanschlüsse G1/8 oder 1/8-27 NPT

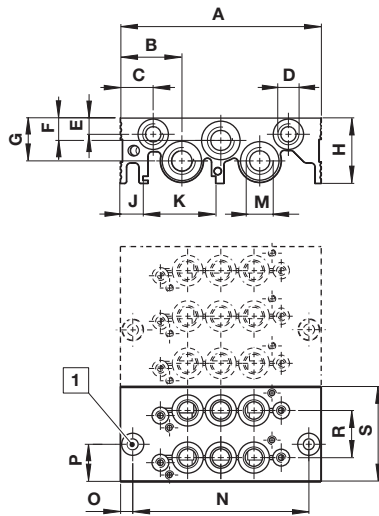
Nr.	A	B	C	D	E	F	G	H	I	J	K	L	M	N	O	P	Q	R	U	V	W	X	Typ
46	118,5	66	32,5	4,5	33,5	8	71	14	26	35	28	—	50	G1/8	43,5	17	22	3,2	6,5	—	16	—	V60A6DDA—...
46	118,5	66	32,5	4,5	33,5	8	71	14	26	35	28	—	50	G1/8	43,5	17	22	3,2	6,5	—	16	—	V60A7DDA—...
46	118,5	66	32,5	4,5	33,5	8	71	14	26	35	28	—	50	G1/8	43,5	17	22	3,2	6,5	—	16	—	V60A8DDA—...
46	142	80	42	4,5	44	10	90	18	26	40	28	—	66	G1/4	53	20	25	3,2	6,5	—	21	—	V61B6DDA—...
46	142	80	42	4,5	44	10	90	18	26	40	28	—	66	G1/4	53	20	25	3,2	6,5	—	21	—	V61B7DDA—...
46	142	80	42	4,5	44	10	90	18	26	40	28	—	66	G1/4	53	20	25	3,2	6,5	—	21	—	V61B8DDA—...
47	170,5	96,5	49	4,5	26	12	108	22,5	36	55	44	33,5	78	G3/8	64	28	34	4,5	8,0	—	24,5	—	V62C6DDA—...
47	170,5	96,5	49	4,5	26	12	108	22,5	36	55	44	33,5	78	G3/8	64	28	34	4,5	8,0	—	24,5	—	V62C7DDA—...
47	170,5	96,5	49	4,5	26	12	108	22,5	36	55	44	33,5	78	G3/8	64	28	34	4,5	8,0	—	24,5	—	V62C8DDA—...
48	216	108	66	7,0	34	16	160	—	50	70	—	41	—	G1/2	98	—	40	—	—	21	33	44	V63D6DDA—...
48	216	108	66	7,0	34	16	160	—	50	70	—	41	—	G1/2	98	—	40	—	—	21	33	44	V63D7DDA—...

Sammelgrundplatte 2-fach und 3-fach

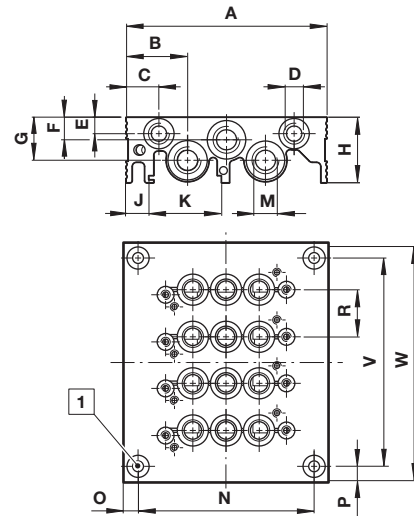

Sammelgrundplatte 4-fach bis 12-fach

 Abmessungen in mm
 Projection/First angle

1 Für M5 Schrauben

Serie	Ventilstation	A	B	C	D	E	F	G	H	J	K	M	N	O	P	R	S	V *2)	W *2)	Gewicht (kg) *2)	Typ
V60	2	98	30	16	G1/8	8	11	21	32	11	35,5	G1/4	86	6	28	23	46	—	46	0,23	2221002
V60	3	98	30	16	G1/8	8	11	21	32	11	35,5	G1/4	86	6	28	23	69	—	69	0,28	2221003
V60	4 » 12	98	30	16	G1/8	8	11	21	32	11	35,5	G1/4	86	6	6,5	23	—	(N x 23) +10	(N x 23) +23	4 stations = 0,61 *2)	22210*1)
V61	2	104	26	9	G1/8	8	13	20	33	10	35,5	G3/8	24	40	26	26	52	—	52	0,28	2221102
V61	3	104	26	9	G1/8	8	13	20	33	10	35,5	G3/8	24	40	52	26	78	—	78	0,45	2221103
V61	4 » 12	104	26	9	G1/8	8	13	20	33	10	35,5	G3/8	24	40	6,5	26	—	(N x 26) +10	(N x 26) +23	4 stations = 0,72 *2)	22211*1)
V62	2	120	29	9	G1/8	8	15	22	38	12	35,5	G1/2	32	44	35	35	70	—	70	0,50	2221202
V62	3	120	29	9	G1/8	8	15	22	38	12	35,5	G1/2	32	44	70	35	105	—	105	0,85	2221203
V62	4 » 12	120	29	9	G1/8	8	15	22	38	12	35,5	G1/2	32	44	7	35	—	(N x 35) +12	(N x 35) +26	4 stations = 1,25 *2)	22212*1)

*1) Bitte ergänzen Sie den Typ der Sammelgrundplatten durch 04, 06, 08, 10 und 12 entsprechend den Ventilplätzen

*2) je weitere zwei Ventilplätze +0,25 für V60, +0,30 für V61 sowie +0,54 für V62

Montageanweisung

Druckabspernteil

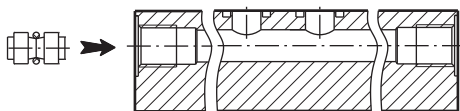

1. Positionieren des Stopfens im P-Kanal der Batterie an der gewünschten Sperrstelle.

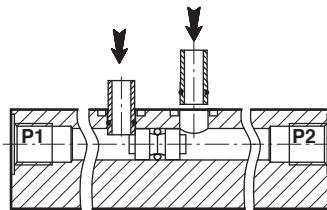

2. Fixieren des Stopfens durch Einstecken der beiden Buchsen.

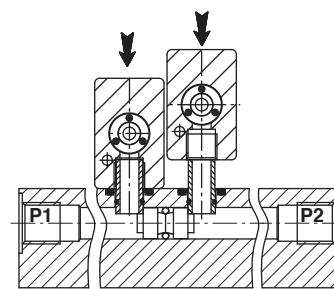

3. Montage der Ventile auf der Grundplatte (Buchsen ragen in die Anschlussgewinde).

**Erweiterungsmöglichkeiten
der Sammelgrundplatten**

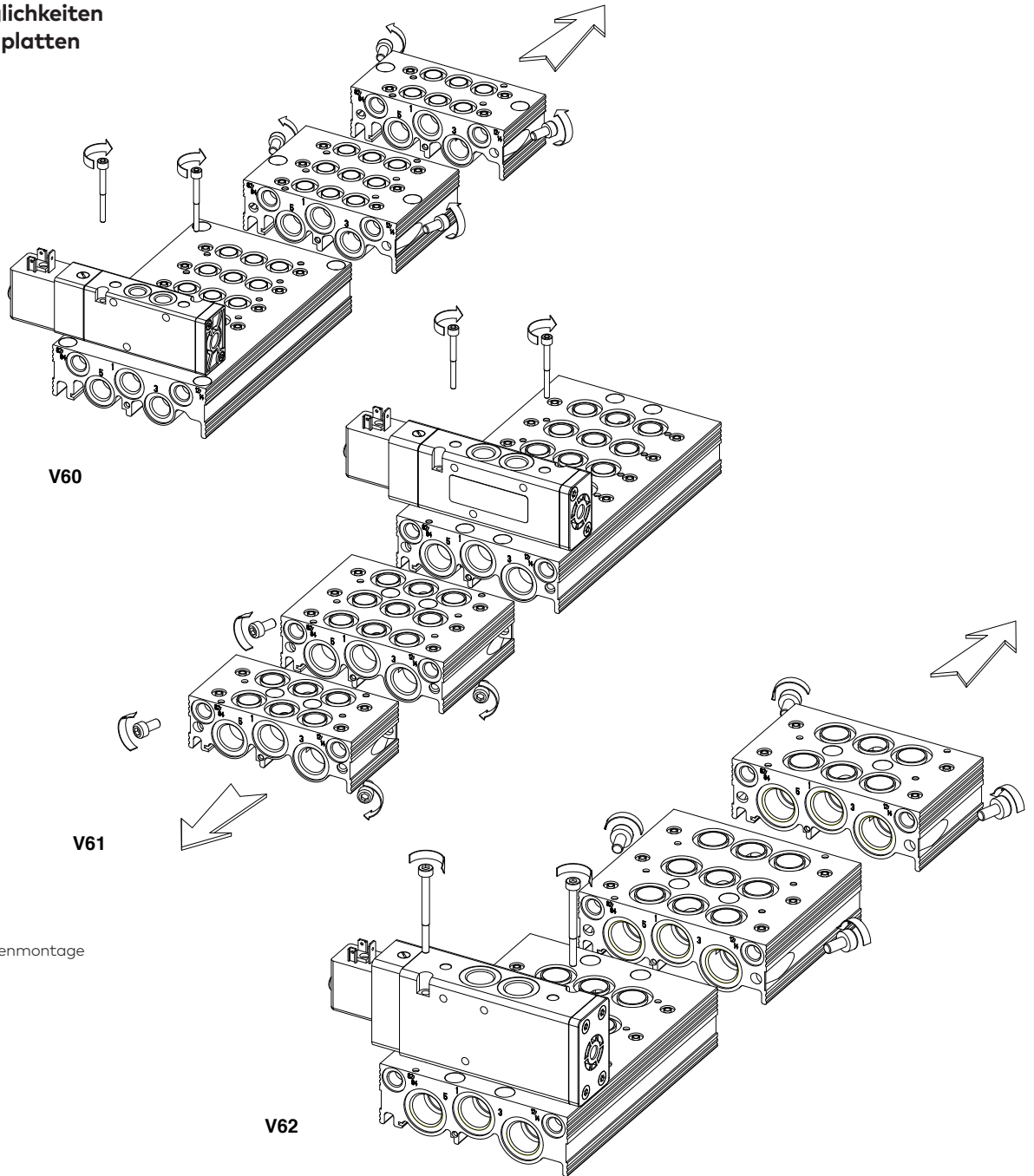

Anzugmomente für Plattenmontage
und Verkettung
 M3 = 0,7 +0,3 Nm
 M4 = 1,6 +0,5 Nm
 M5 = 3,4 +0,5 Nm
 M6 = 5,2 +0,5 Nm

**Befestigungssatz
für DIN-Schiene**

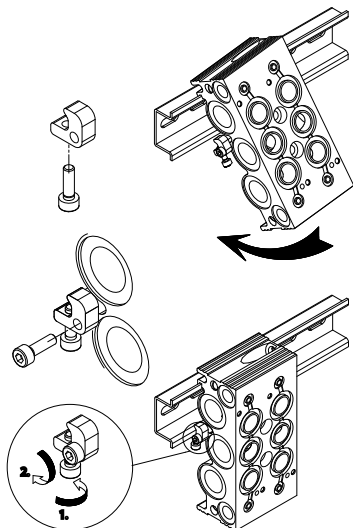

Sammelanschlussleiste

Abmessungen in mm
Projection/First angle

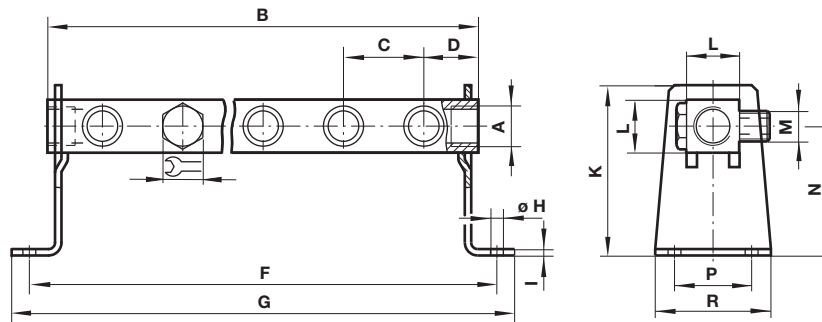

Serie	Ventil- plätze	A	B	C	D	E	F	G	Ø H	I	K	L	M	N	P	R	Gewicht (kg)	Typ
V60	2	G1/4	76	32	22	14	90	106	6,5	2,5	60	16	G1/8	48	28	42	0,053	2639622
V60	3	G1/4	108	32	22	14	122	138	6,5	2,5	60	16	G1/8	48	28	42	0,075	2639623
V60	4	G1/4	140	32	22	14	154	170	6,5	2,5	60	16	G1/8	48	28	42	0,099	2639624
V60	5	G1/4	172	32	22	14	186	202	6,5	2,5	60	16	G1/8	48	28	42	0,123	2639625
V60	6	G1/4	204	32	22	14	218	234	6,5	2,5	60	16	G1/8	48	28	42	0,147	2639626
V60	7	G1/4	236	32	22	14	250	266	6,5	2,5	60	16	G1/8	48	28	42	0,174	2639627
V60	8	G1/4	268	32	22	14	282	298	6,5	2,5	60	16	G1/8	48	28	42	0,194	2639628
V60	9	G1/4	300	32	22	14	314	330	6,5	2,5	60	16	G1/8	48	28	42	0,209	2639629
V60	10	G1/4	332	32	22	14	346	362	6,5	2,5	60	16	G1/8	48	28	42	0,230	2639630
V60	12	G1/4	396	32	22	14	410	426	6,5	2,5	60	16	G1/8	48	28	42	0,280	2639632
V61	2	G3/8	85	35	25	19	100	116	6,5	3	75	23	G1/4	57	35	50	0,130	2639422
V61	3	G3/8	120	35	25	19	135	151	6,5	3	75	23	G1/4	57	35	50	0,192	2639423
V61	4	G3/8	155	35	25	19	170	186	6,5	3	75	23	G1/4	57	35	50	0,250	2639424
V61	5	G3/8	190	35	25	19	205	221	6,5	3	75	23	G1/4	57	35	50	0,309	2639425
V61	6	G3/8	225	35	25	19	240	256	6,5	3	75	23	G1/4	57	35	50	0,367	2639426
V61	7	G3/8	260	35	25	19	275	291	6,5	3	75	23	G1/4	57	35	50	0,421	2639427
V61	8	G3/8	295	35	25	19	310	326	6,5	3	75	23	G1/4	57	35	50	0,482	2639428
V61	9	G3/8	330	35	25	19	345	361	6,5	3	75	23	G1/4	57	35	50	0,537	2639429
V61	10	G3/8	365	35	25	19	380	396	6,5	3	75	23	G1/4	57	35	50	0,595	2639430
V61	12	G3/8	435	35	25	19	450	466	6,5	3	75	23	G1/4	57	35	50	0,642	2639432

Sicherheitshinweise

Diese Produkte sind ausschließlich in Druckluftsystemen zu verwenden. Sie sind dort einzusetzen, wo die unter »**Technische Merkmale/-Daten**« aufgeführten Werte nicht überschritten werden.

Berücksichtigen Sie bitte die entsprechende Katalogseite. Vor dem Einsatz der Produkte bei nicht industriellen Anwendungen, in lebenserhaltenden- oder anderen Systemen, die nicht in den veröffentlichten Anleitungsunterlagen enthalten sind, wenden Sie sich bitte direkt an Norgren. Durch Missbrauch, Verschleiß oder Störungen können in Pneumatiksystemen verwendete Komponenten auf verschiedene Arten versagen.

Systemauslegern wird dringend empfohlen, die Störungsarten aller in Pneumatiksystemen verwendeten Komponententeile zu berücksichtigen und ausreichende Sicherheitsvorkehrungen zu treffen, um Verletzungen von Personen sowie Beschädigungen der Geräte im Falle einer solchen Störung zu verhindern.

Systemausleger sind verpflichtet, Sicherheitshinweise für den Endbenutzer im Betriebshandbuch zu vermerken, wenn der Störungschutz nicht ausreichend gewährleistet ist.